





Desarrollos únicos que son tendencia



Última actualización 01/08/2025

## PUERTAS Y VENTANAS CORREDIZAS MANUAL TÉCNICO













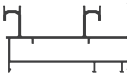
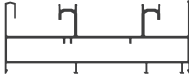



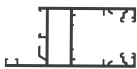









 (0351)695 7920  [aluwind.com.ar](http://aluwind.com.ar)    AluwindSA

 Av. Japón 550 - Córdoba, Argentina



INDICE	PÁGINA
Listado de perfiles	3
Perfiles esc.1:1	5
Descuentos corredizas	9
Listado de accesorios	11
Verificaciones - RotoFrank	12
Verificaciones - Giesse	18
Verificaciones - Fapim	23
Vistas y detalles de corredizas	26
Dimensiones recomendadas de fabricación	36

CÓDIGO	DESCRIPCIÓN	PESO Kg/m	FORMA	L. Std.
AW 540	Guia Mosquitero	0,479		6,2
AW 569	Guia acoplable corrediza corte a 45°	0,887		6,2
AW 568	Marco puerta y ventana corrediza corte a 45°	1,465		6,2
AW 570	Marco coplanar de 3 guias	1,947		6,2
AW 565	Guia postiza (anodizada)	0,115		6,2
AW 542	Union interior de guias corredizas	0,424		6,2
AW 517	Hoja a 45° corrediza DVH	1,540		6,2
AW 518	Hoja a 45° corrediza VS	1,605		6,2
AW 558	Hoja corrediza recta corte a 45°	1,577		6,2
AW 559	Contravidrio de 2.7mm para AW 558	0.148		6,2
AW 572	Contravidrio de 20mm para AW 558	0.203		6,2
AW 037e	Hoja mosquitero	0,529		6,2
AW 035e	Tapa Hoja mosquitero	0,166		6,2
AW 566	Travesaño Mosquitero	0,486		6,2
AW 567	Refuerzo Mosquitero	0,470		6,2

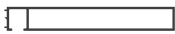
CÓDIGO	DESCRIPCIÓN	PESO Kg/m	FORMA	L. Std.
AW 520	Encuentro recto hoja 45°	0,48		6,2
AW 592	Cruce SLIM reforzado	1,769		6,2
AW 593	Cruce SLIM sin refuerzo	0,770		6,2
AW 555	Acople a 90° -Guia simple corrediza 1 hoja	1,33		6,2
AW 513	Tapa junta curvo	0,240		6,2
AW 514	Tapa junta recto	0,304		6,2
AW 407	Encuentro central	0,391		6,2
AW 533	Refuerzo	0,827		6,2
AW 571	Tope de hoja ventana y puerta corrediza	0,115		6,2
AW 515	Premarco 50 mm	0,52		6,2
AW 564	Premarco 68mm	0,564		6,2
AW 596	Premarco corrediza 3 hojas	0,993		6,2

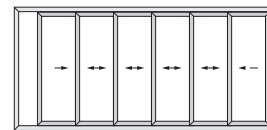

## PERFILES DE CORREDIZA

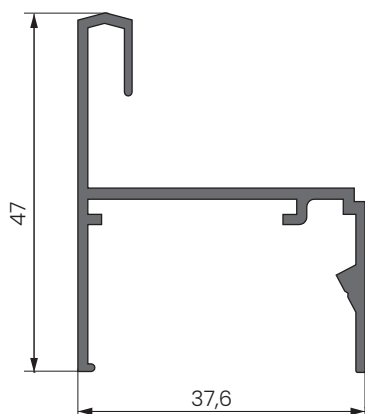

**AW 540**

Guía de mosquitero (acoplable)  
0,479 Kg/m

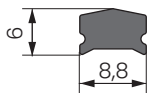

**AW 565**

Guía postiza  
(anodizada)  
0,115 Kg/m

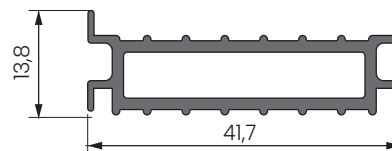

**AW 542**

Union interior de guías  
0.424Kg/m

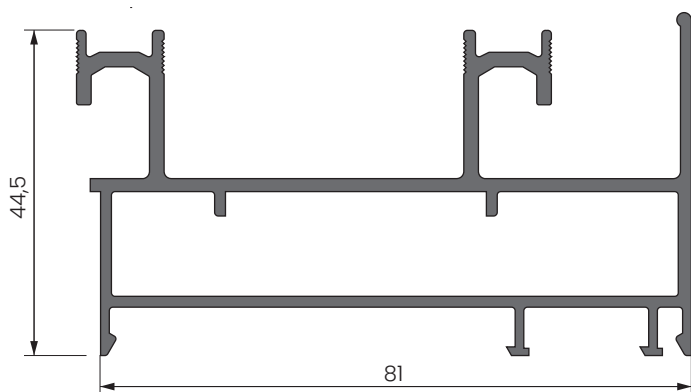

**AW 568**

Marco dos guías corrediza a 45°  
1,465 Kg/m

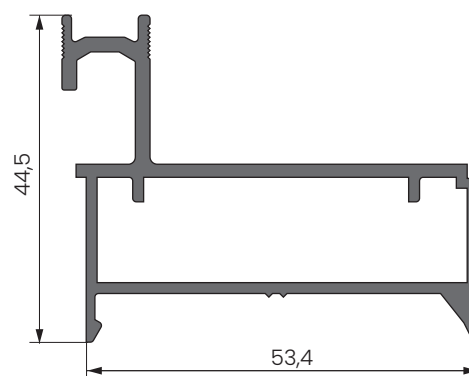

**AW 569**

Marco corrediza una guía (acoplable)  
0.888Kg/m

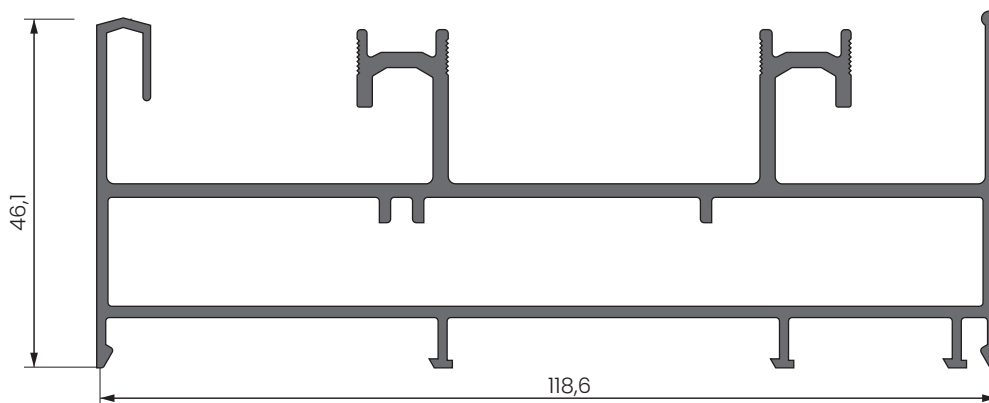

**AW 570**

Marco coplanar 3 guías corrediza a 45°  
1,947Kg/m

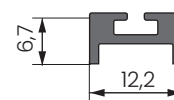

**AW 571**

Tope hoja corrediza  
0,115 Kg/m

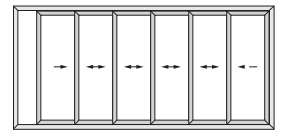

PERFILES DE CORREDIZA

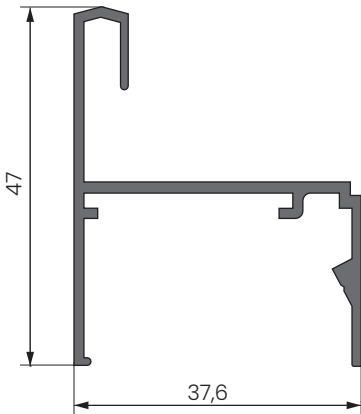

**AW 540**

Guía de mosquitero (acoplable)  
0,479 Kg/m

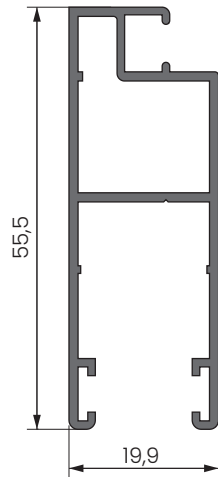

**AW 037e**

Hoja mosquitero  
0,529 Kg/m

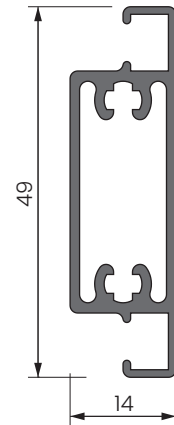

**AW 566**

Travesaño mosquitero  
0,486 Kg/m

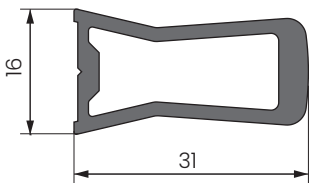

**AW 567**

Refuerzo mosquitero  
0,470 Kg/m

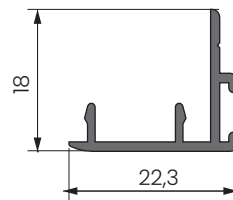

**AW 035e**

Tapa hoja mosquitero  
0,522 Kg/m

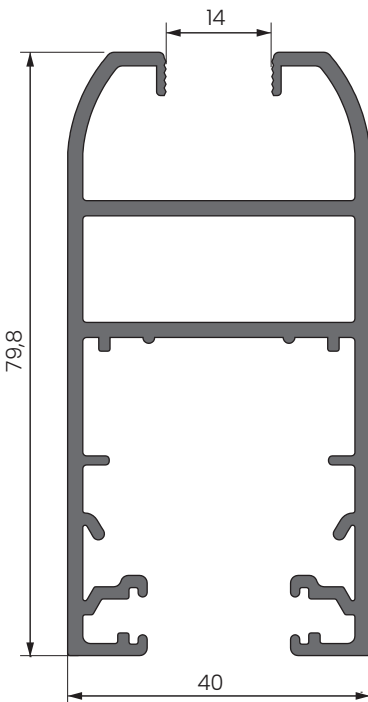

**AW 518**

Hoja a 45° corrediza VS  
1.605Kg/m

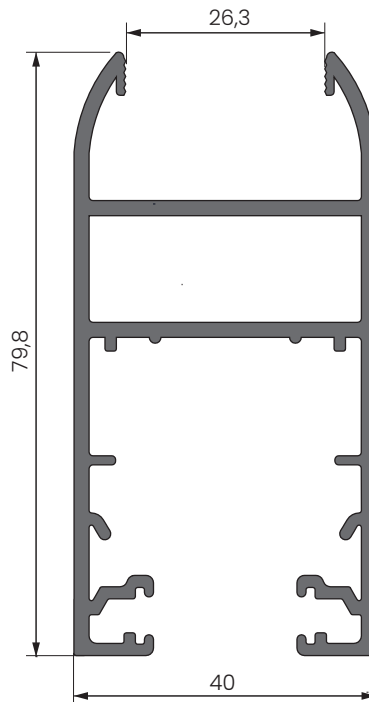

**AW 517**

Hoja a 45° corrediza DVH  
1.540 Kg/m

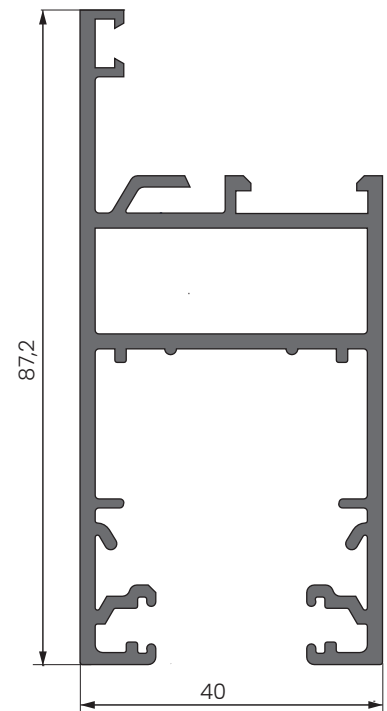

**AW 558**

Hoja recta corrediza, corte a 45°  
1.577Kg/m

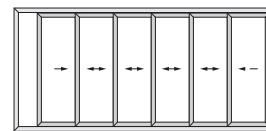

## PERFILES DE CORREDIZA

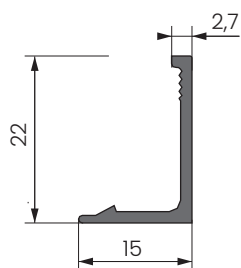

### AW 559

Contravidrio de 2,7mm  
para hoja 558 - 0,148 Kg/m

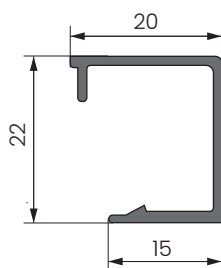

### AW 572

Contravidrio de 2,0mm  
para hoja 558 - 0,203 Kg/m

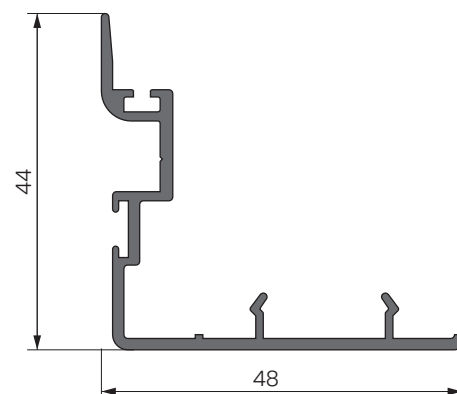

### AW 520

Encuentro hoja a 45°  
0,480 Kg/m

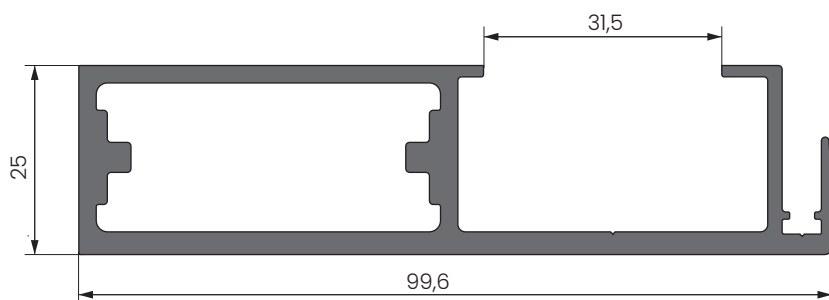

### AW 592

Cruce slim DVH con refuerzo  
1,844 Kg/m

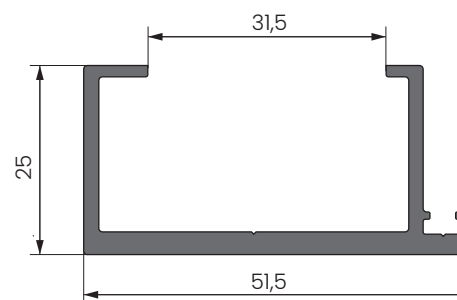

### AW 593

Cruce slim DVH  
0,845 Kg/m

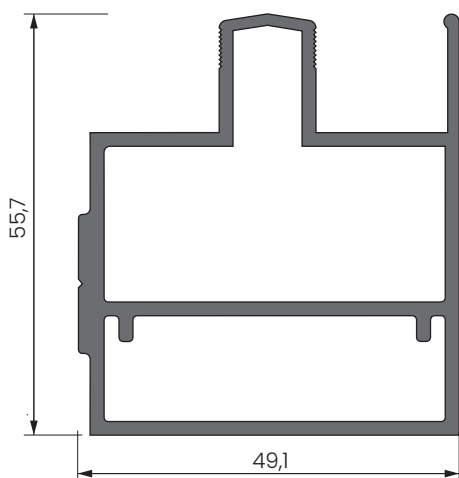

### AW 555

Acople a 90° recto - Guia corrediza 1 hoja  
1,201 Kg/m

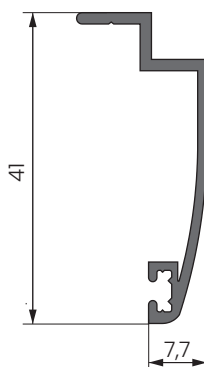

### AW 513

Tapajuntas curvo  
0,240 Kg/m

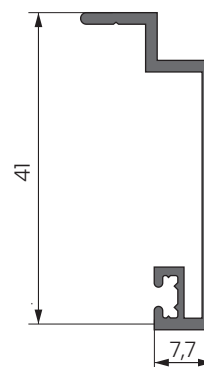

### AW 514

Tapajuntas recto  
0,304 Kg/m

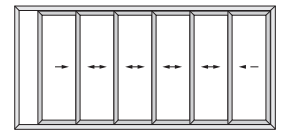

## COMPLEMENTOS

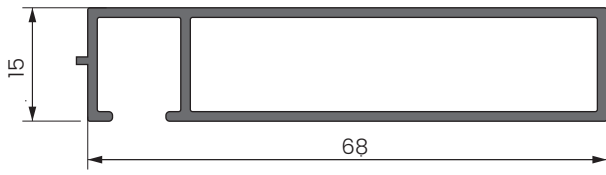

### AW 564

Premarco 68mm  
0,564 Kg/m

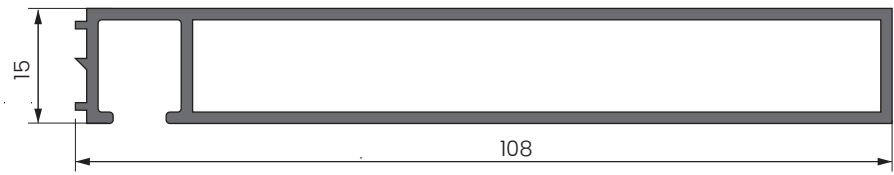

### AW 596

Premarco 108mm, corrediza 3 guias  
0,993 Kg/m

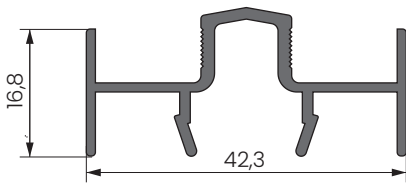

### AW 407

Encuentro central  
0,391 Kg/m

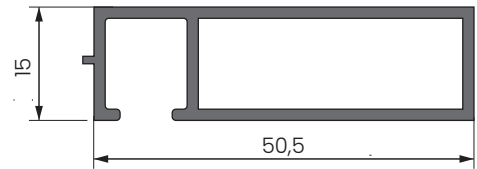

### AW 515

Premarco 50mm  
0,523 Kg/m

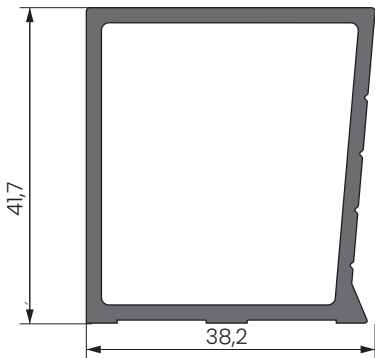

### AW 533

Refuerzo / manijon  
0,827Kg/m

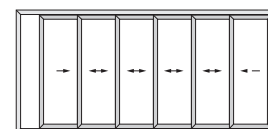

### DESCUENTOS

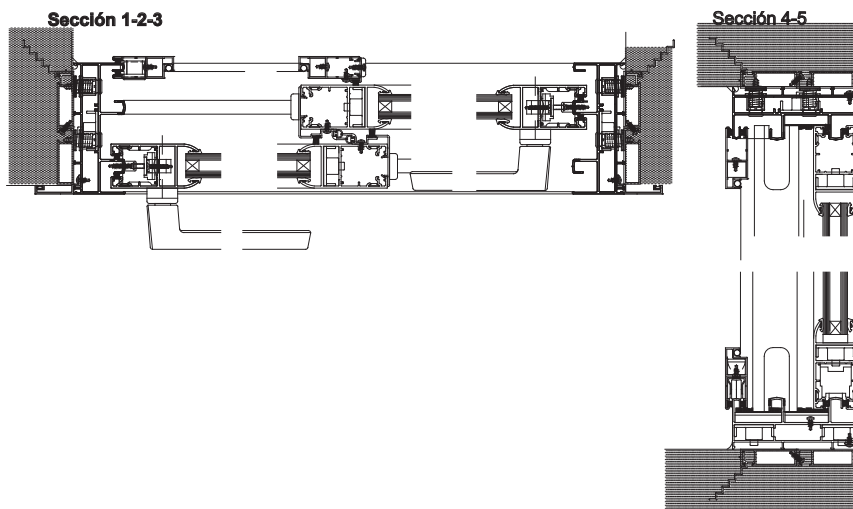
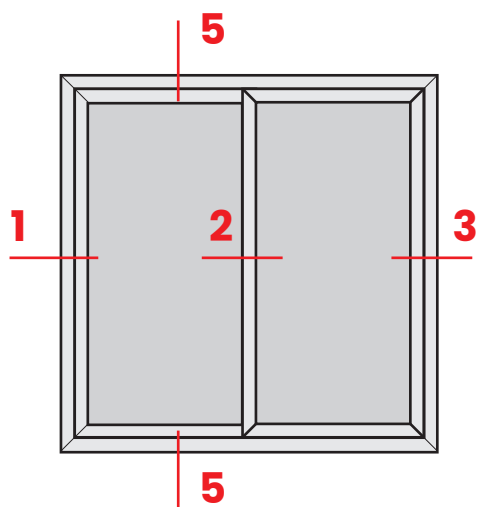

CANT.	PERFIL	PESO GR/M	MEDIDA	DESCRIPCIÓN	CORTE
2	AW-515	523	A+36	Premarco dintel y zocalo	45° - 45°
2	AW-515	523	H+18	Premarco jambas	45° - 45°
2	AW-514	257	A+70	Dintel y zocalo tapajuntas recto	45° - 45°
2	AW-514	257	H+35	Jambas tapajuntas recto	45° - 90°
2	AW-570/ AW-568	1947/1465	A y H	Marco	45° - 45°
2	AW-565	86	A - 84	Sombrilla para guía de marco	90°
4	AW-571	158	H - 48	Portaburlete tope de hoja	90°
4	AW-558 / AW-517	1577/1570	(A/2)+2	Dintel y zocalo hoja (2 hojas y 2 guías)	45° - 45°
6	AW-558 / AW-517	1577/1570	(A/3)+29	Dintel y zocalo hoja (3 hojas y 3 guías)	45° - 45°
6	AW-558 / AW-517	1577/1570	(A/4)+43	Dintel y zocalo hoja (4 hojas y 4 guías)	45° - 45°
6	AW-558 / AW-517	1577/1570	(A/5)+51	Dintel y zocalo hoja (5 hojas y 5 guías)	45° - 45°
4	AW-558 / AW-517	1577/1570	H-73	Jambas hoja	45° - 45°
2	AW-559	148	A/2-126	Dintel y zocalo contravidrio (2 hojas)	45° - 45°
6	AW-559	148	A/3-96	Dintel y zocalo contravidrio (3 hojas)	45° - 45°
8	AW-559	148	A/4-85	Dintel y zocalo contravidrio (4 hojas)	45° - 45°
10	AW-559	148	A/5-80	Dintel y zocalo contravidrio (5 hojas)	45° - 45°
2	AW-559	148	H-204	Jambas contravidrio	45° - 45°
2	AW-520	475	H-74	Perfil cruce de hojas	90°
2	AW-037e	483	(A/2)-21	Dintel y zocalo hoja mosq. (2 hojas y 2 guías)	45° - 45°
2	AW-037e	483	(A/3)+5	Dintel y zocalo hoja mosq. (3hojas y 3 guías)	45° - 45°
2	AW-037e	483	H-74	Jambas hoja mosquitero	45° - 45°
2	AWT-540	434	A Y H	Guía mosquitero	45° - 45°
1	AWT-035e	166	H-74	Tapa hoja de mosquitero	90°

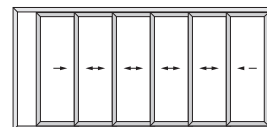





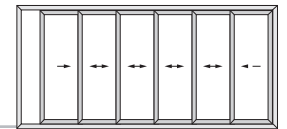

### DESCUENTOS EN VIDRIOS

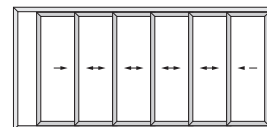
CANT.	TIPO	ANCHO	ALTO	DESCRIPCIÓN	HOJA
2	VS	(A/2)-148	H-226	VIDRIO SIMPLE	AW-558
2	DVH	(A/2)-148	H-226	VIDRIO DOBLE VIDRIADO HERMÉTICO	AW-558
2	VS	(A/2)-134	H-212	VIDRIO SIMPLE	AW-517/AW518
2	DVH	(A/2)-134	H-212	VIDRIO DOBLE VIDRIADO HERMÉTICO	AW-517/AW-518





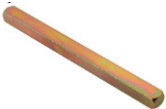

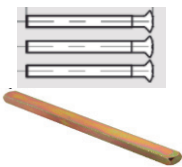
DESCRIPCIÓN	IMAGEN	CODIGO	CANT. POR ABERTURA	MARCA
TOPE PARANTE LATERAL (tope de hojas con marco) <i>Venta por unidad</i>		TOPE T4	4	ALUWIND PEDIDOS WEB!
BURLETE CRUCE DE HOJAS A 45°/ CIERRE HERMETICO JAMBAS <i>Venta por rollos de 100m</i>		RPC	Toda la longitud encuentro AW3007	ALUWIND PEDIDOS WEB!
ANTIVIBRACION / PATIN <i>Paquete por 100 unidades</i>		AA-002	8	ALUWIND PEDIDOS WEB! MONPAT
BURLETE CRUCE / CIERRE HERMETICO JAMBAS <i>Venta por rollos de 50m</i>		I-62	longitud del perfil AW573-AW574	ALUWIND PEDIDOS WEB!
TAPA SUPERIOR E INFERIOR PARA COLUMNA EN ESQUINA AW555 <i>Paquete por 2 unidades</i>		T555B (blanco)	1 par	ALUWIND PEDIDOS WEB!
		T555N (negro)		
		T529G (gris)		
TAPA SUPERIOR PARA CRUCE SLIM <i>Paquete por 10 unidades</i>		TA73 (anodizada) TA73N (negro)	1	ALUWIND PEDIDOS WEB!
CAJA VINCULADORA HOJA/ CRUCE <i>Paquete por 10 unidades</i>		CJ-02	1	ALUWIND PEDIDOS WEB!
ESCUADRA DE PREMARCOS		E78	4	MONPAT
ESCUADRA DE ALINEACION TAPAJUNTAS		AA-107	2	MONPAT
ESCUADRA ARMADO HOJAS MOSQUITERO		AA-300	4	MONPAT
ESCUADRA DE ALINEAMIENTO DE HOJA		E-66	16	TANIT
ESCUADRA DE HOJA		AA-003 / E-83	12	TANIT
ESCUADRA ARMADO MARCOS			4	
RUEDA REGULABLE DOBLE		R-47	4	GIESSE - ROTO PABOSE
RUEDA MOSQUITERO		615951	4	ROTO FRANK
		CARRO TRIESTE		MONPAT
TOPE PARANTE CENTRAL		T-118	4	MONPAT
TACO REGULADOR		T-88	-	FRIUL TRADE
TOPE MOSQUITERO/ANTI RUIDO 16		T-90	4	MONPAT
CONTRAVIENTO		AA-209	4	MONPAT
BURLETE CUERDA MOSQUITERO		B-9	-	LIGOM
BURLETE CUÑA		B29 / B30 / B31	-	LIGOM

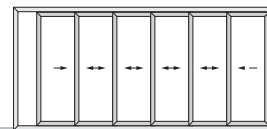

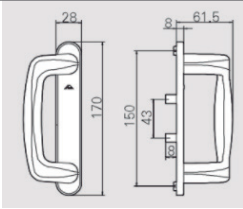
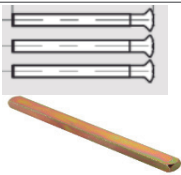
	DESCRIPCIÓN	IMAGEN	CODIGO	CANT. POR ABERTURA	MARCA
	Falleba Rotoline		Blanco (cod.490545)	2	ROTO FRANK
			Negro (cod.490546)		
			Gris (cod.339532)		
	Falleba Rotoline con CERRADURA		Blanco (cod.228043)	2	
			Gris (cod.228040)		
Kit falleba acodada	Falleba multipunto acodada (izquierda y derecha)		Acodada DERECHA Blanca (cod.375816)	2	
			Acodada DERECHA Negro (cod.570511)		
			Acodada DERECHA Gris (cod.375814)		
			Acodada IZQUIERDA Blanco (cod.375320)		
			Acodada IZQUIERDA Negro (cod.570510)		
	Acodada IZQUIERDA Gris (cod.375319)				
Cuadradillo para falleba acodada		287824	2 (1 cuadradillo por cada falleba acodada)		
Kit de manijon para interior	Tirador, ventana corrediza Interior (manijon interior)		Blanco (cod.613226)	2	
			Negro (cod.613225)		
			Gris (cod.613222)		
Kit de tornillos y cuadradillo		613181 1 kit - incluye: Tornillos para manijon (3) Cuadradillo de bronce (1)	2 (1 kit por cada manijon)		

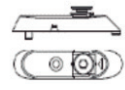

	DESCRIPCIÓN	IMAGEN	CODIGO	CANT. POR ABERTURA	MARCA
Kit de manijon para Exterior (opcional)	Tirador, ventana corrediza Interior (manijon interior)		Blanco (cod. 613191)	2	ROTO FRANK
			Negro (cod. 613190)		
			Gris (cod. 613187)		
Kit de tornillos y cuadradillo		613181 1 kit - incluye: Tornillos para manijon (3) Cuadradillo de bronce (1)	2 (1 kit por cada manijon)		
Kit uñero pop-up de embutir	Uñero multipunto embutir con pop-up (trae cuadradillo de bronce incluido)		Blanco (cod. 570810)	2	
			Negro (cod.614295)		
			Gris (cod.637963)		
Tornillos para uñero (2 tornillos por uñero)		490 014T Tornillos para uñero (2)	2 (1 kit por cada uñero)		
Cierre multipunto	Cierre multipunto		Mecanismo de 600mm (cod. 628484)	2	
			Mecanismo de 1800mm (cod. 628498)		
	Cerradero		834431 en mecanismo de 600mm. Sin prueba 478413. Lleva suplemento plastico	2	
			834431 en mecanismo de 1800mm. Sin prueba practica 478413. Lleva suplemento plastico	4	
	Anti Falsa maniobra		343733	1	

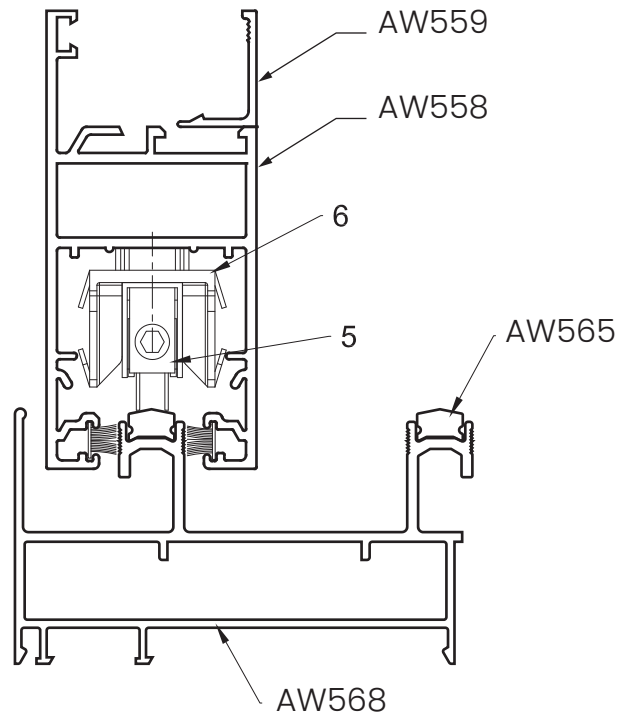
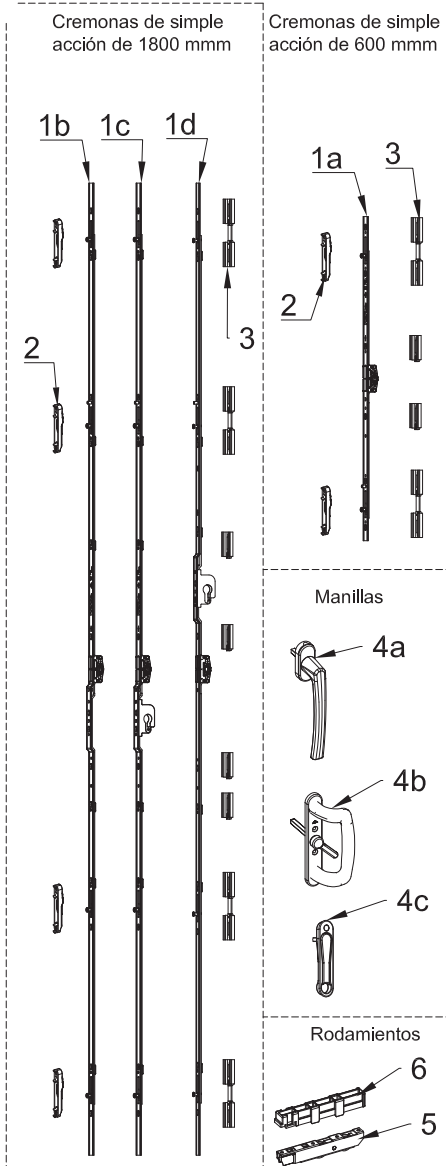
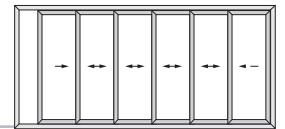

Pos. Nr	SAP	DESCRIPCIÓN	Pos. Nr	SAP	DESCRIPCIÓN
1A	628484	IS ESPAG NT 600 2CAM-8 BS17	4C	637960	POP-UP HANDLE 21 MM
1B	628498	IS ESPAG NT 1800 4CAM-8 BS17	5	639325	ROLLER
1C	628499	IS ESPAG NT 1800 LA 4CAM-8 BS17	6	642371	PACKER FOR ROLLERS
1D	772745	IS ESPAG NT 1800 LA 4CAM-8 BS17			
2	478413	STRIKER			
3	564314	SET SEPARATOR S007 VE 6 ST (3x2) ALU IS			
4A	490545	ROTO LINE HANDLE			
4B	553031	ROTO LINE SLIDING HANDLE			

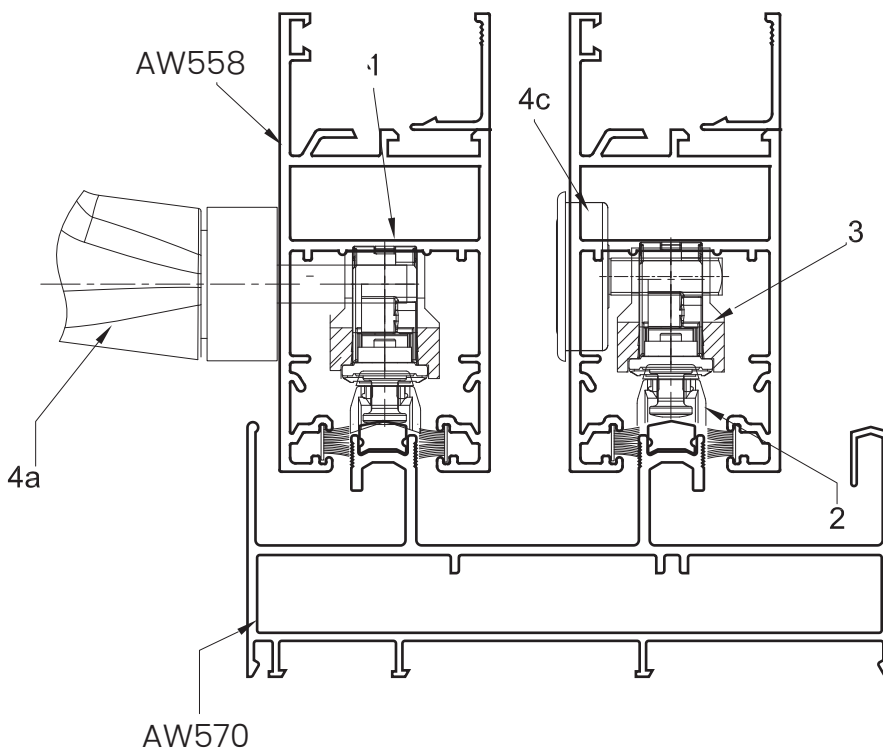

Propuesta de dibujo para coordinación con el fabricante de perfiles.

Para comprobar la información contenida en el dibujo, una primera ventana de muestra debe ser construida.

Instrucciones de montaje, mecanizaciones el CTL 9



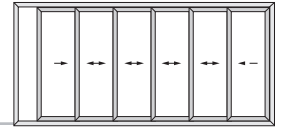

Mecanizado manilla RotoLine

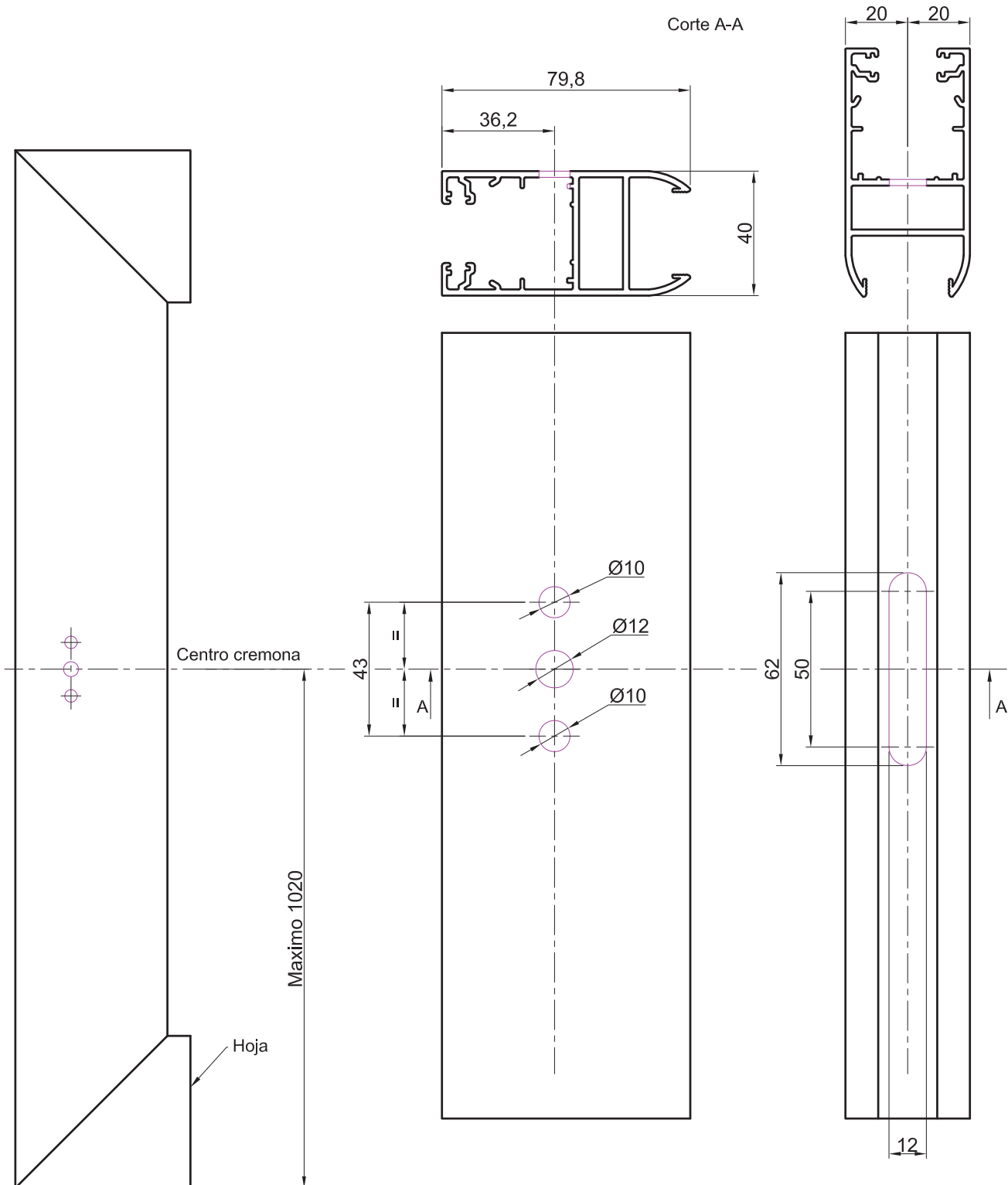

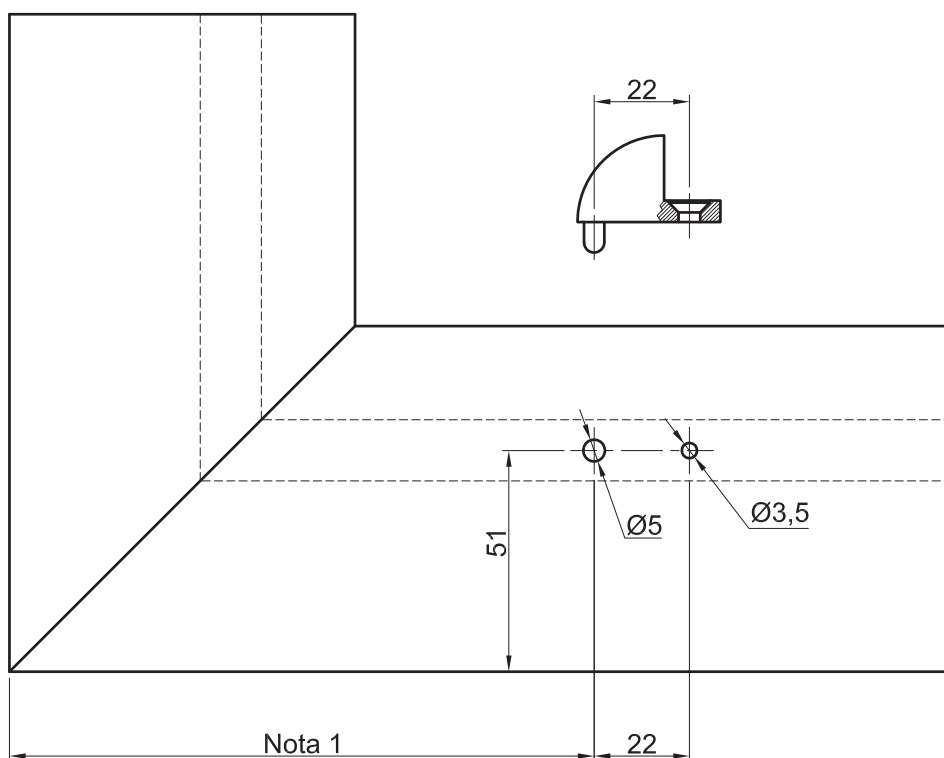
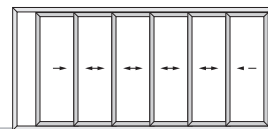

1<sup>a</sup> La posición del tope es la distancia que hay que dejar para que no impacten la manilla o el cruce de hojas.

2<sup>o</sup> Hacer dos taladros uno a Ø5 mm y otro de Ø 3.5 mm. según dibujo.

3<sup>o</sup> Introducir la pieza y atornillar con un tornillo de Ø4.2 mm x longitud

4<sup>o</sup> Una vez fijada la pieza de metal, montamos el amortiguador

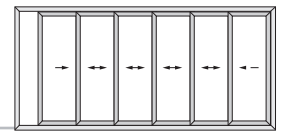

MECANIZADO POP UP

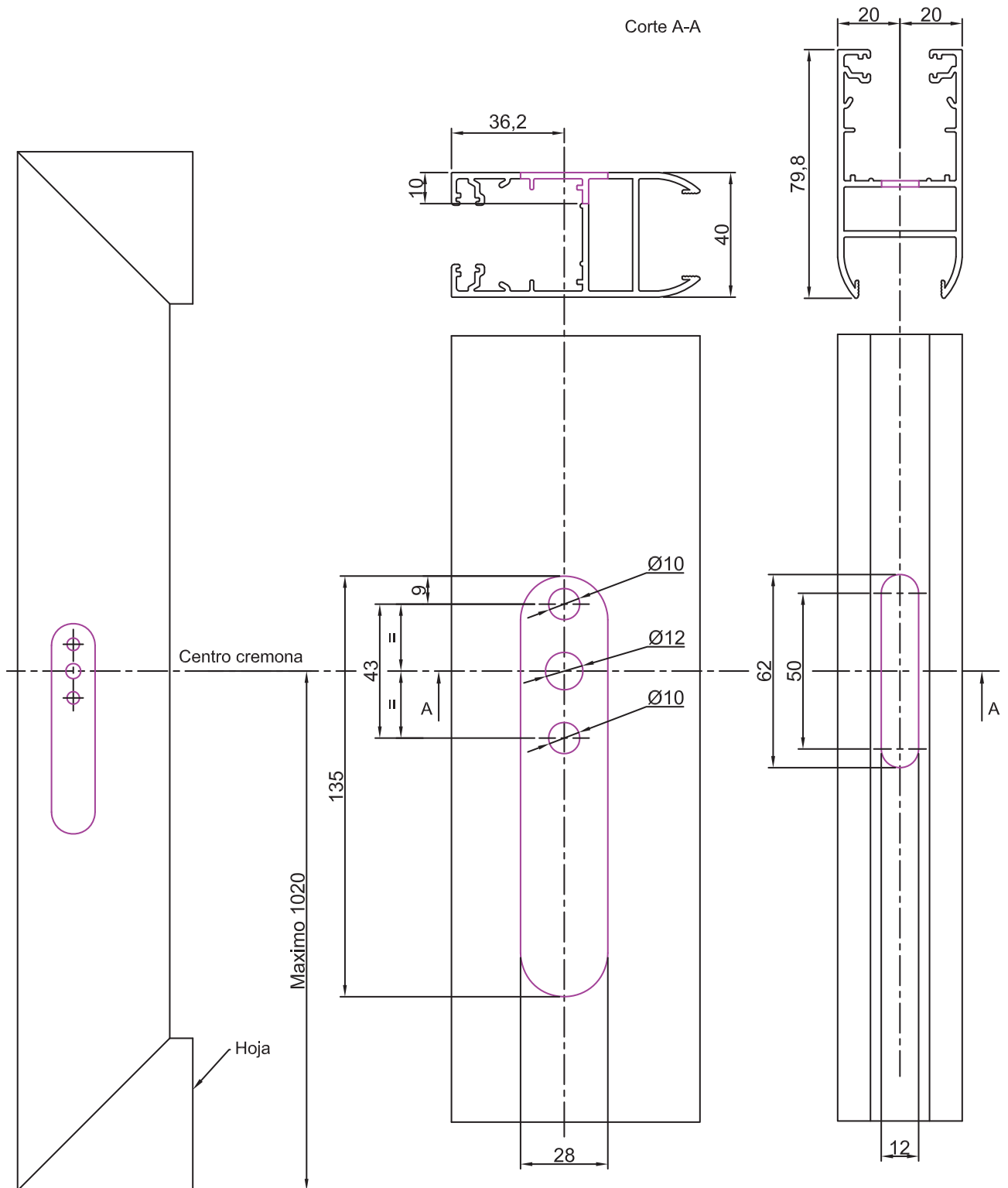

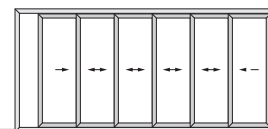

DESCRIPCIÓN	IMAGEN	CODIGO	CANT. POR ABERTURA	MARCA
CIERRE MULTIPUNTO CHAMPION PLUS		02725 (600MM) 02726 (1000MM) 06310 (1600MM)  02728 (1800 c/ cerradero)	2	Cierre MULTIPUNTO
KIT IMPERIA		06482 (2 puntos) 06483 (3 puntos)	2	
MARTELINA PRIMA		02762	2	
MARTELINA KORA		00997		
MARTELINA ASIA		02415		
UÑERO EXT.		02764		
ANTI FALSA MANIOBRA		02770	2	
CIERRES BRIO		02992N (brio) 02983N (brio plus) 02892N (brio key) 02988N (brio mini)	2	Cierre LATERAL
KIT IMPERIA		05005	2	
FLECHA		02597	2	
GANCHO		03336	2	

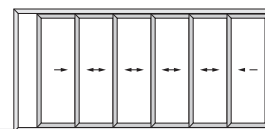

### CIERRE MULTIPUNTO

KIT 06431 - 06432 - 06433

CIERRE MULTIPUNTO  
 ENTRADA 7,5 MM  
 02721 CHAMPION PLUS 600  
 02722 CHAMPION PLUS 1000  
 06309 CHAMPION PLUS 1600  
 02723 CHAMPION PLUS 1800

06432 KIT ADAPT. 2P  
 06433 KIT ADAPT. 3P

MARTELINAS  
 02762 PRIMA  
 00997 KORA  
 02415 ASIA  
 02764 UÑERO EXT

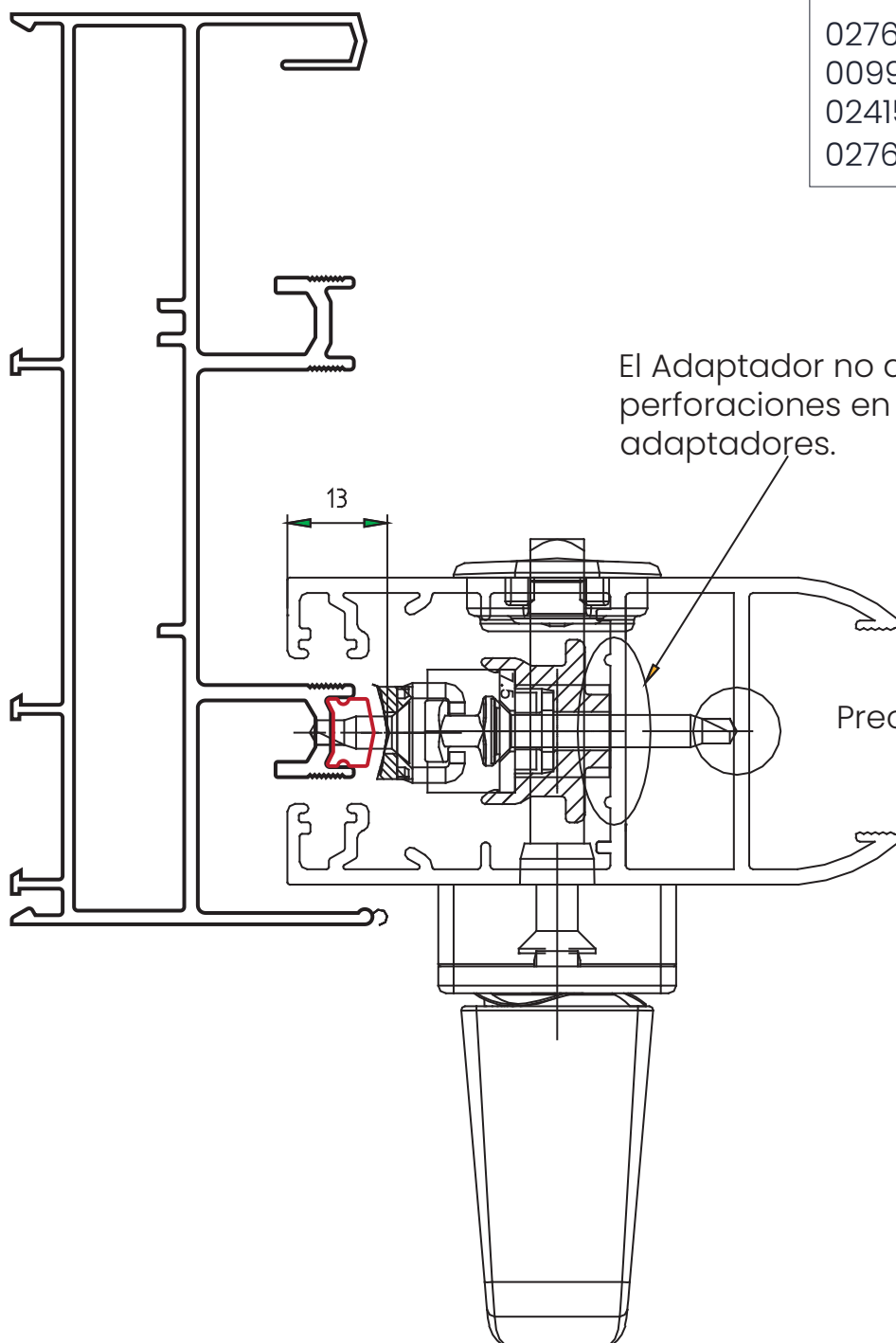

El Adaptador no queda centrado. Realizar perforaciones en el centro, antes de fijar los adaptadores.

Precaución, zona de vidrio

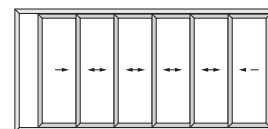

### CIERRE MULTIPUNTO

#### CIERRE MULTIPUNTO

ENTRADA 15 MM

02725 CHAMPION PLUS 600

02726 CHAMPION PLUS 1000

06310 CHAMPION PLUS 1600

02727 CHAMPION PLUS 1800

02728 1800 C/CERRAD

06432 KIT ADAPT. 2P

06433 KIT ADAPT. 3P

#### MARTELINAS

02762 PRIMA

00997 KORA

02415 ASIA

02764 UÑERO EXT

KIT 06481 - 06482 - 06483

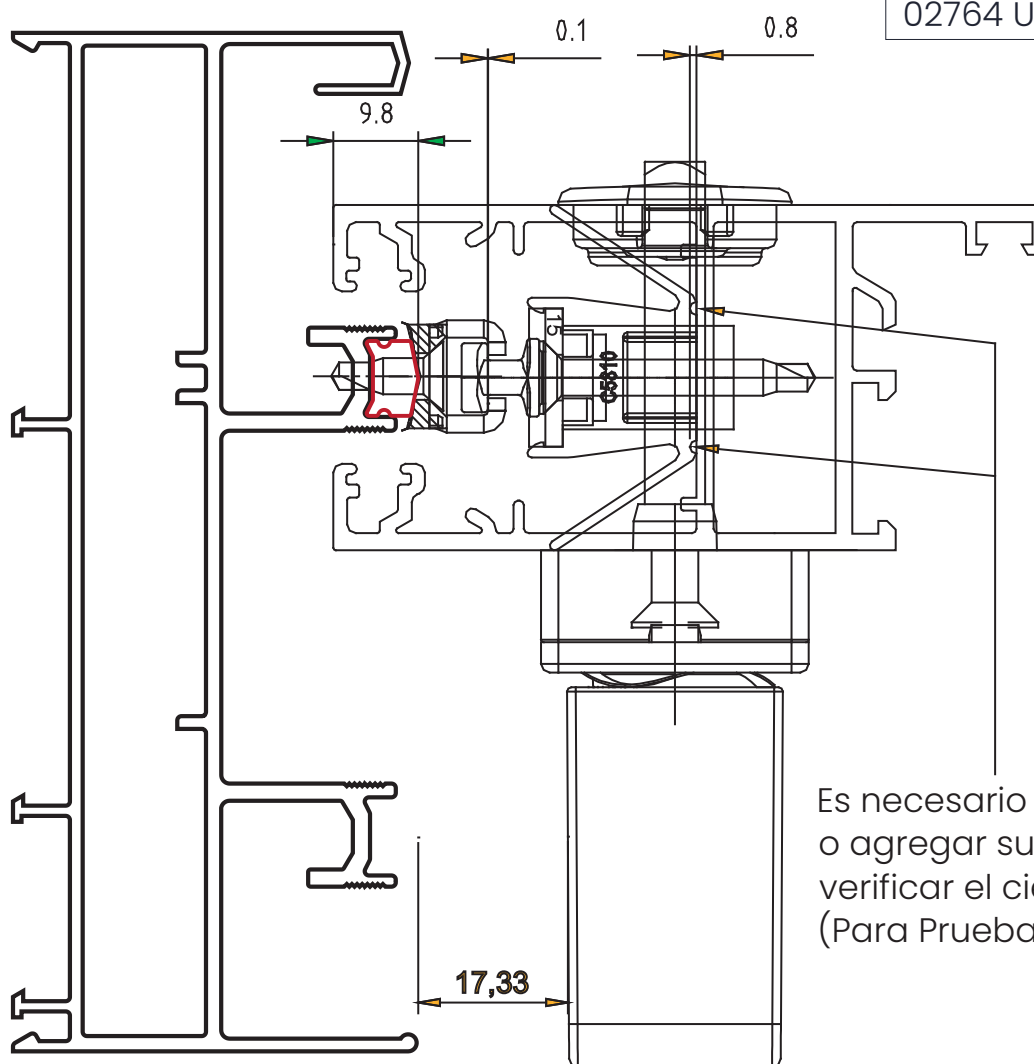

Es necesario refilar los adaptadores, o agregar suplemento de relleno y verificar el cierre.  
(Para Prueba Practica)

Distancia minima  
recomendada 20mm.

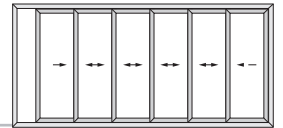

### CIERRE LATERAL

CIERRES	BRIO
02992N	BRIO
02983N	BRIO PLUS
02892N	BRIO KEY
02988N	BRIO MINI
02597	FLECHA
03336	GANCHO

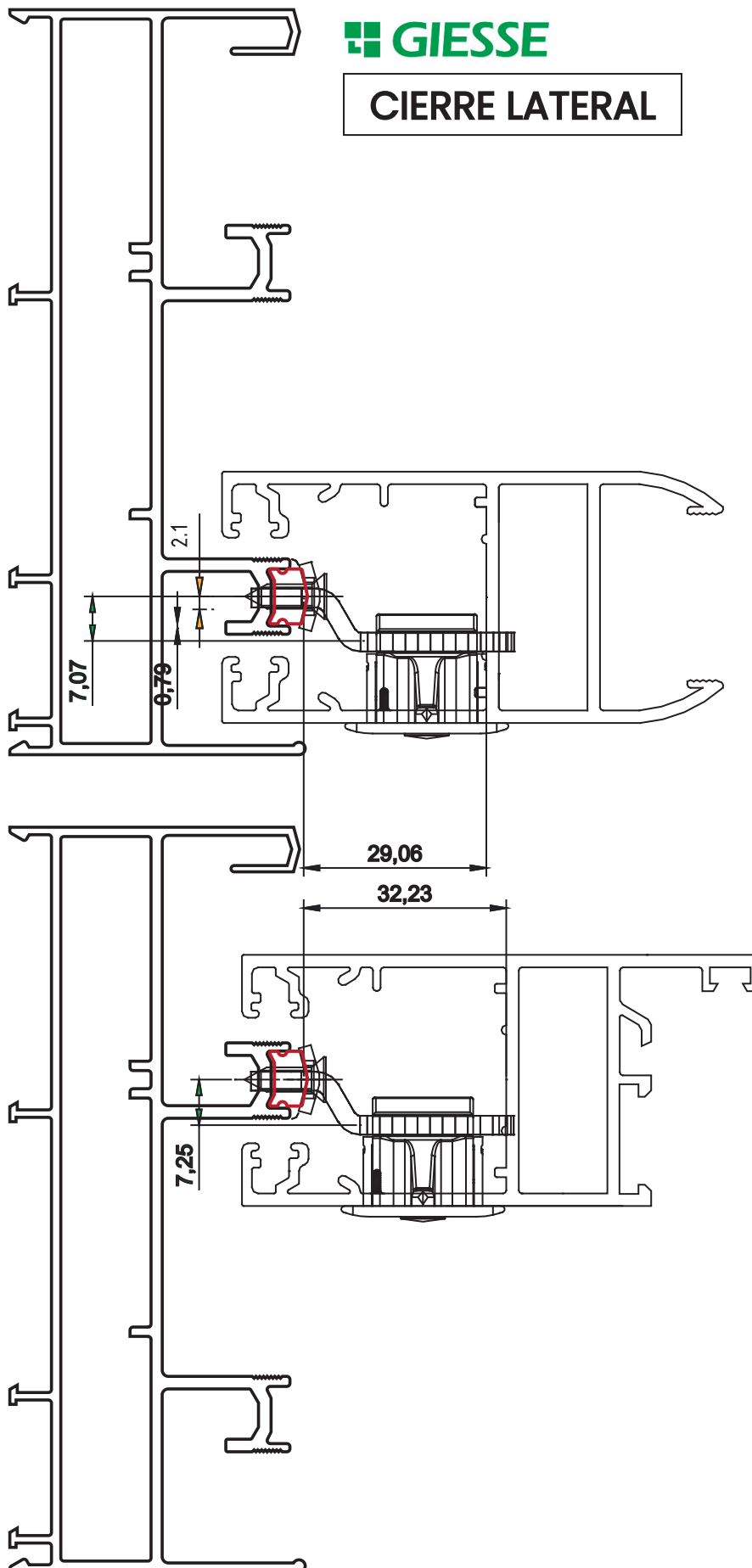

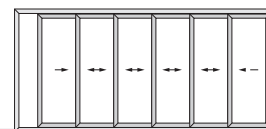





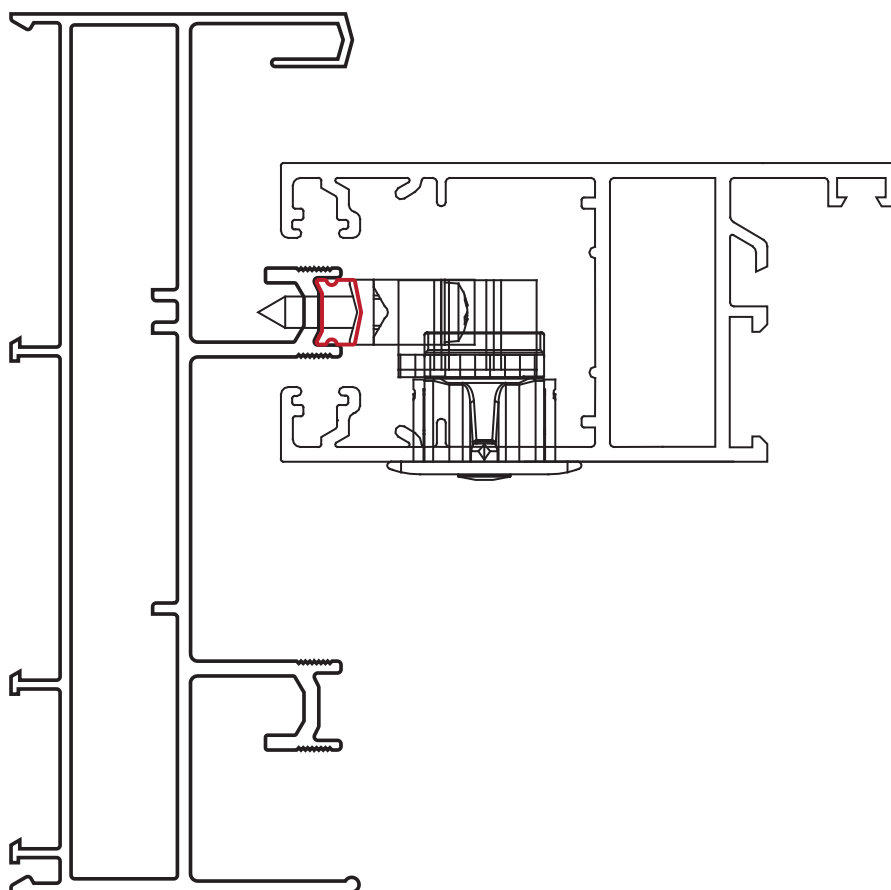
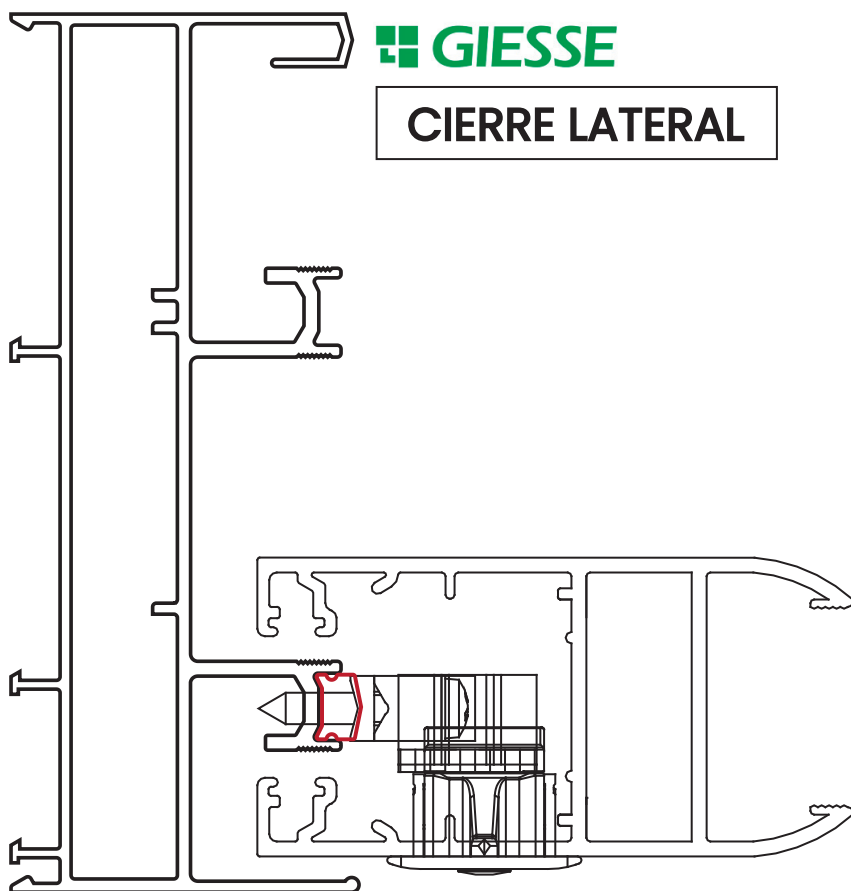

**GIESSE**

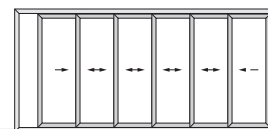
**CIERRE LATERAL**

CIERRES BRIO	
02992N	BRIO
02983N	BRIO PLUS
02892N	BRIO KEY
02988N	BRIO MINI
05005	KIT



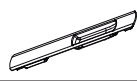
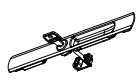
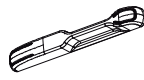
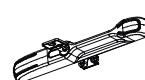
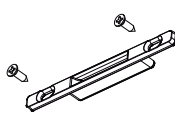

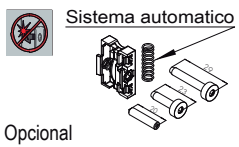

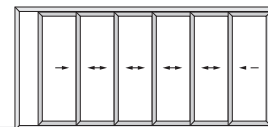

DESCRIPCIÓN	IMAGEN	CODIGO	CANT. POR ABERTURA	MARCA
GANCHO DE MARCO EMBUTIDO CIERRE OLE TOP		5003AA 5003AB	2	FAPIM para CORREDIZA A 45°
CIERRE OLE TOP		5003CA 5003CB	2	
CIERRE OLE TOP CON LLAVE		5004AA 5004AB	2	
CUBETA EXTERIOR		5013	2	
CUBETA EXTERIOR CON LLAVE		5014	2	
TIRADOR EXTERIOR		5015	2	
TIRADOR EXTERIOR CON LLAVE		5016	2	
CERRADERO		5032A	2	
GANCHO		5023NA	2	
TIRADOR INTERIOR	 Opcional	5010B	2	
ANTI-FALSA MANIOBRA	 Opcional	5020 B	2	

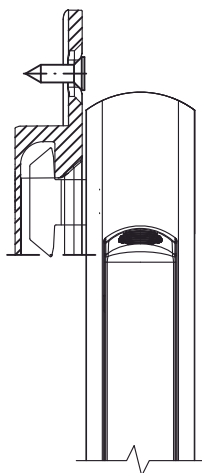
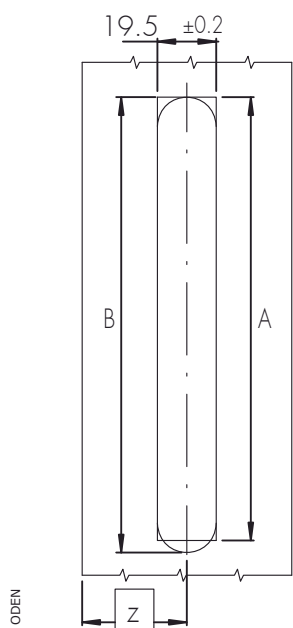

**fapim**

Life in evolution

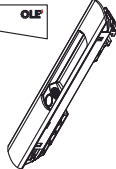
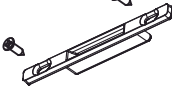

Articulo	Codigo	Descripcion
 	5000AA 5000AB	Cierre OLE
	5032A	Cerradero
	5023NA	Gancho
 Opcional	5010A	Tirador Interior

$141 \leq A \leq 148$

$143 \leq B \leq 150$

**OLE**

**INFORMACION:**  
las letras hacen referencia  
a las hojas de instrucción

### SERIE: IMPERIA CORTE 45 - APLICACION CIERRE LATERAL

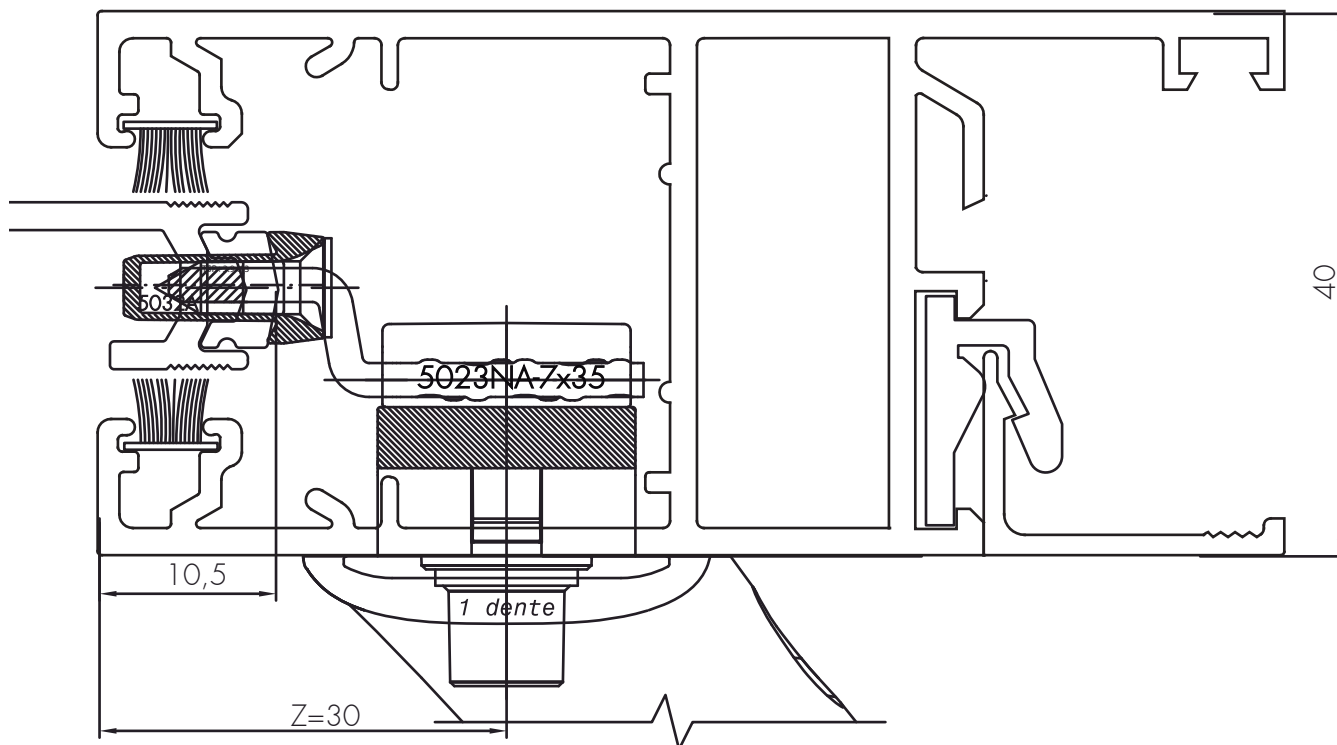

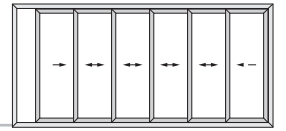



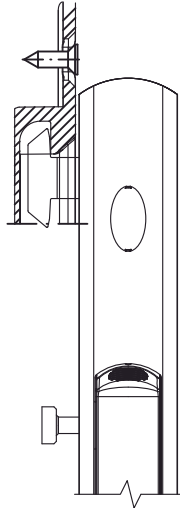
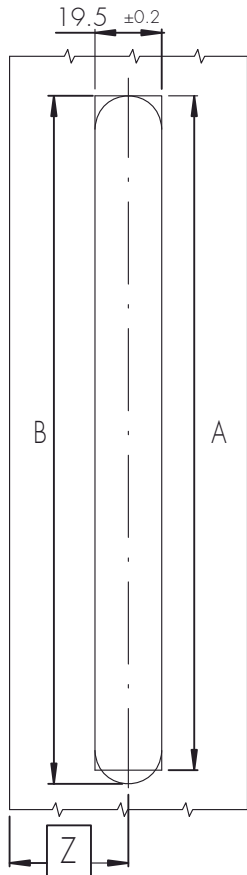

**fapim**  
Life in evolution



$$181 \leq A \leq 188$$

$$183 \leq B \leq 190$$

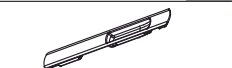
**OLE TOP**

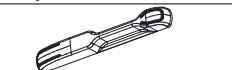
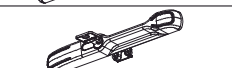
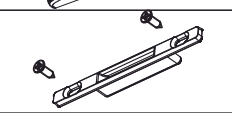
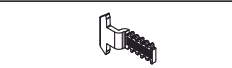
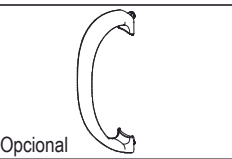
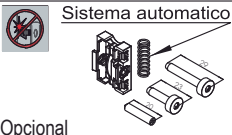
Articulo	Codigo	Descripcion
	5003AA 5003AB	Cierre OLE TOP
	5003CA 5003CB	Cierre OLE TOP
	5004AA 5004AB	Cierre OLE TOP Con llave
	5013	Cubeta exterior
	5014	Cubeta exterior con llave
	5015	Tirador exterior
	5016	Tirador exterior con llave
	5032A	Cerradero
	5023NA	Gancho
	5010B	Tirador Interior
Opcional  Sistema automatico	5020 B	Anti-falsa maniobra

### APLICACION ANTI-FALSA MANIOBRA

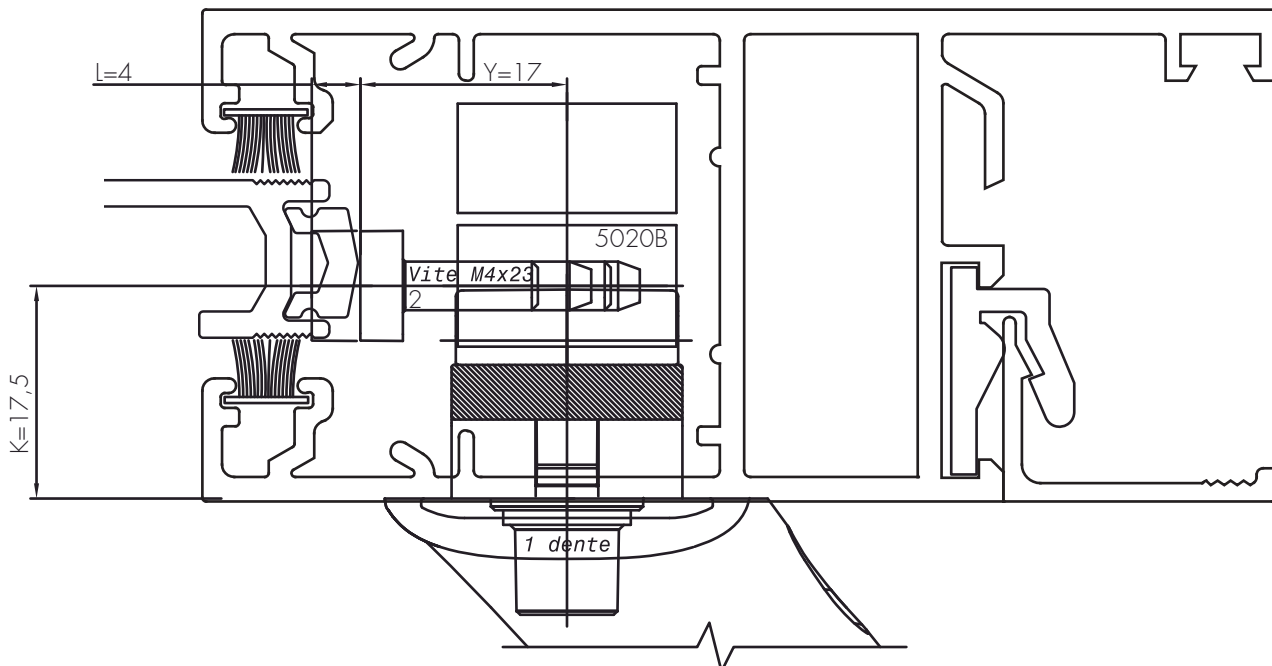

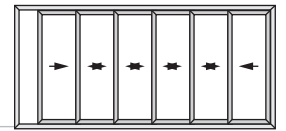

### DETALLE HOJA RECTA CORTE A 45 PARA DVH

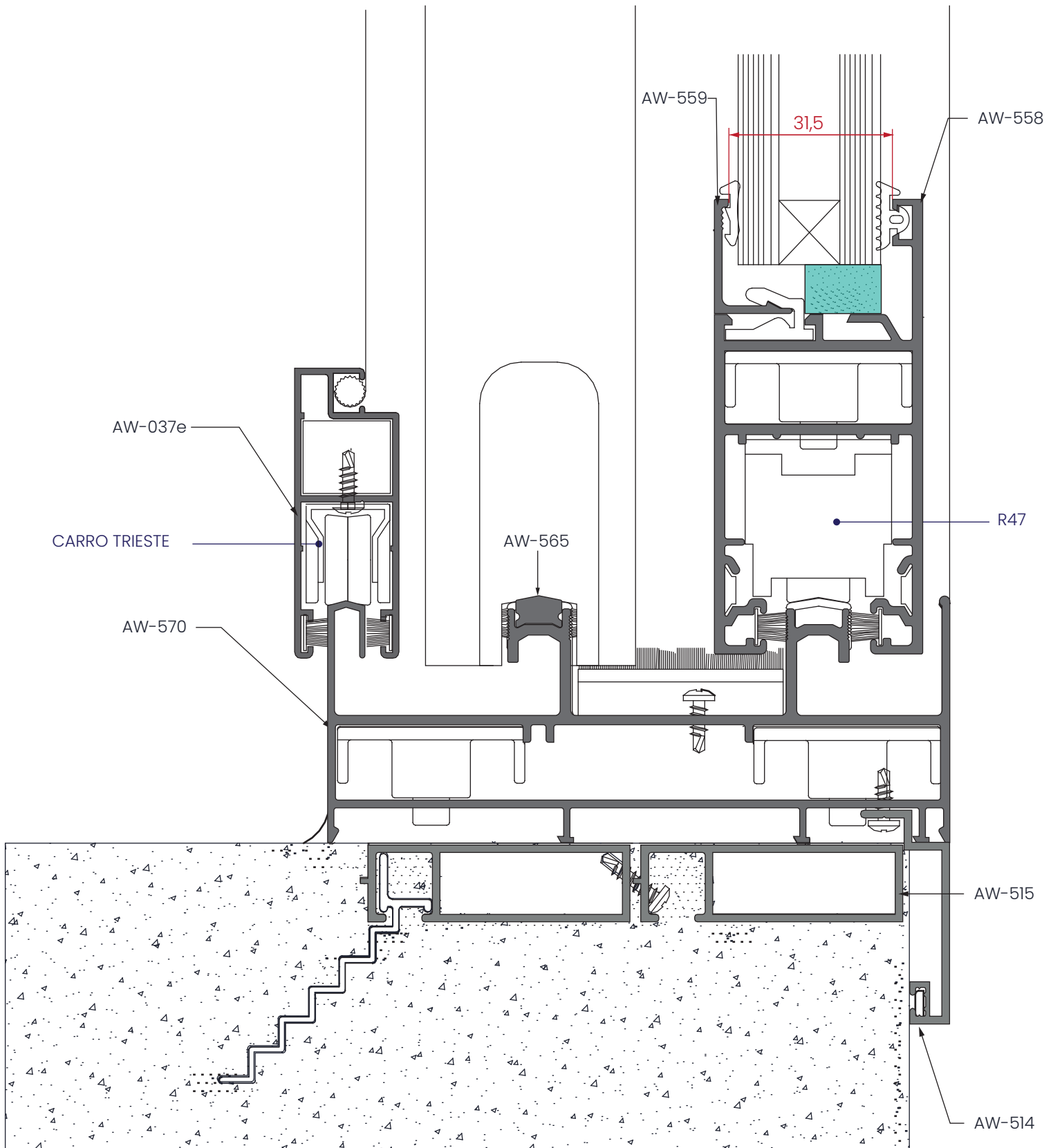

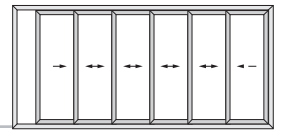

### DETALLE ARMADO DE HOJAS Y COLOCACIÓN DE CARROS

#### Alineación vertical

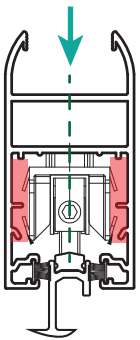

Carro perpendicular al zocalo de marco suplementado con calzos

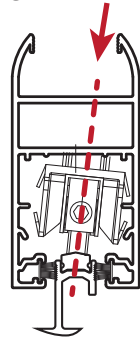

**X** Carro desplazado en eje vertical



Si los carros presentan demasiada holgura en el perfil, deberán suplementarse para reducir oscilaciones transversales.

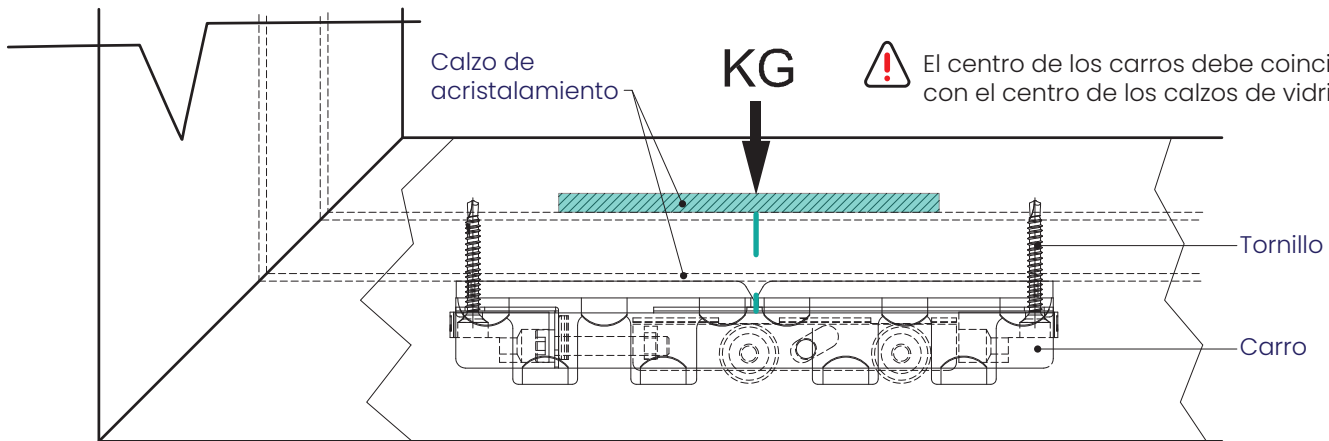

#### Alineación horizontal

Es necesaria una correcta alineación longitudinal en función al par de ruedas, garantizando la colinealidad en el recorrido.

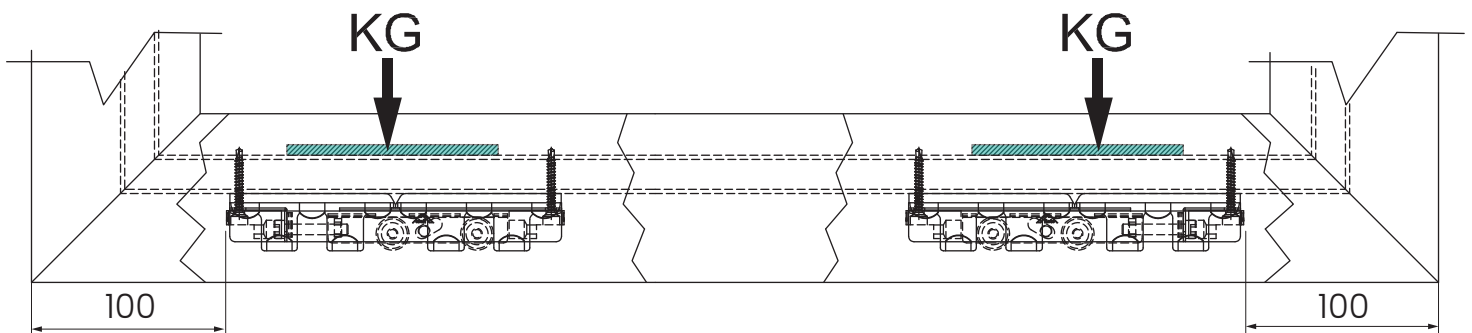
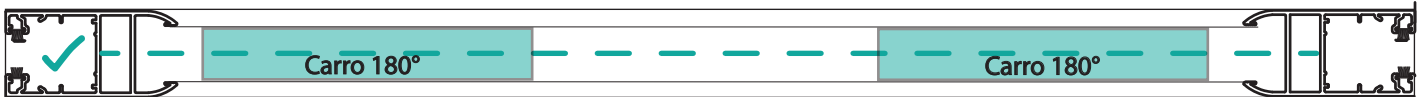

En hojas que superan los 2m de ancho la distancia a los extremos debe ser 300mm

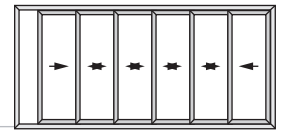

### DETALLE / DINTEL DE MARCO

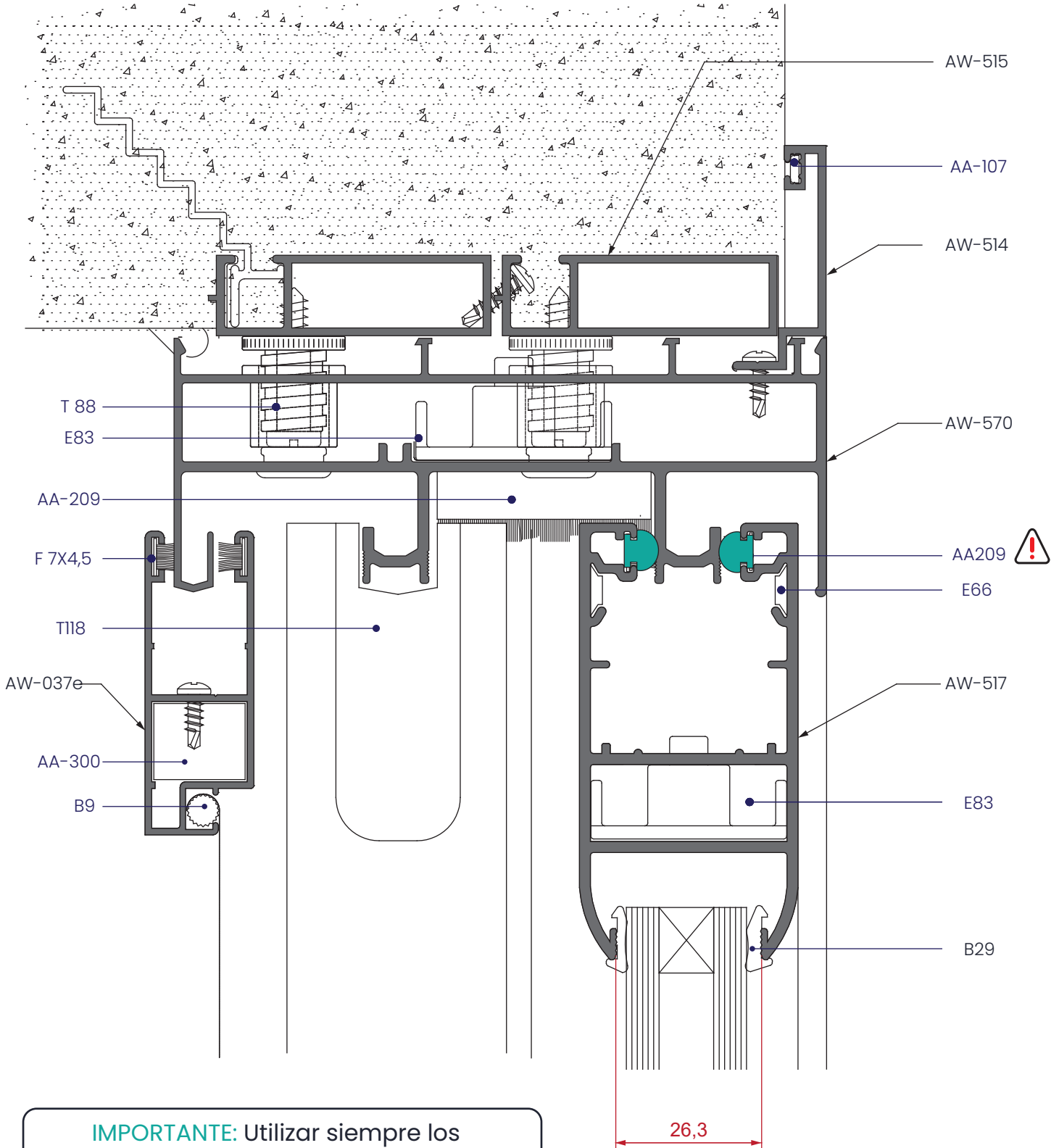

**IMPORTANTE:** Utilizar siempre los patines antivibradores AA209 para evitar que la hoja se descarrile y mantenga la verticalidad.

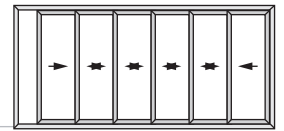

### DETALLE / CIERRE LATERAL CON FALLEBA Y MULTIPUNTO

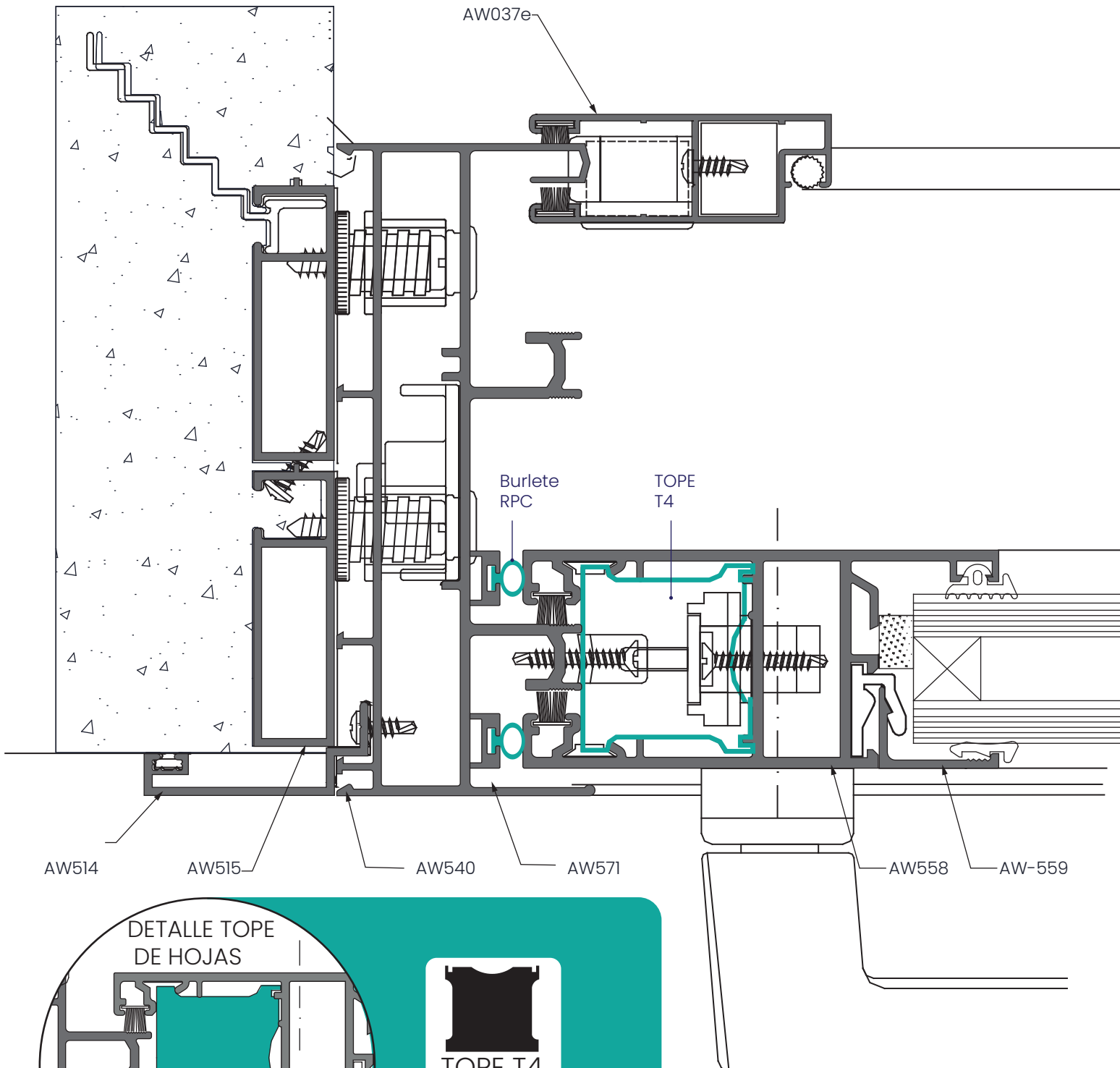

AW514

AW515

AW540

AW571

AW558

AW-559

DETALLE TOPE DE HOJAS

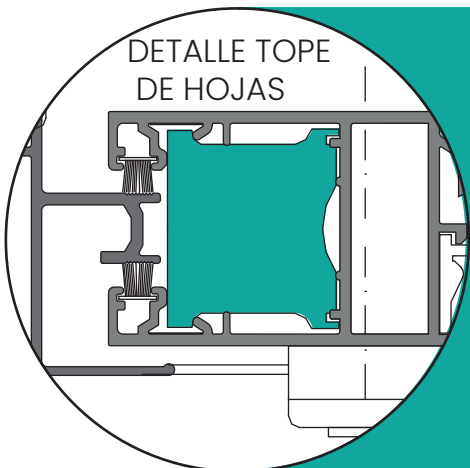

Nota: Es indispensable utilizar SIEMPRE el tope T4 en las jambas, se usan 4 por abertura

## Sección 1

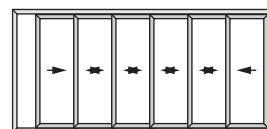

### DETALLE / CRUCE DE HOJAS

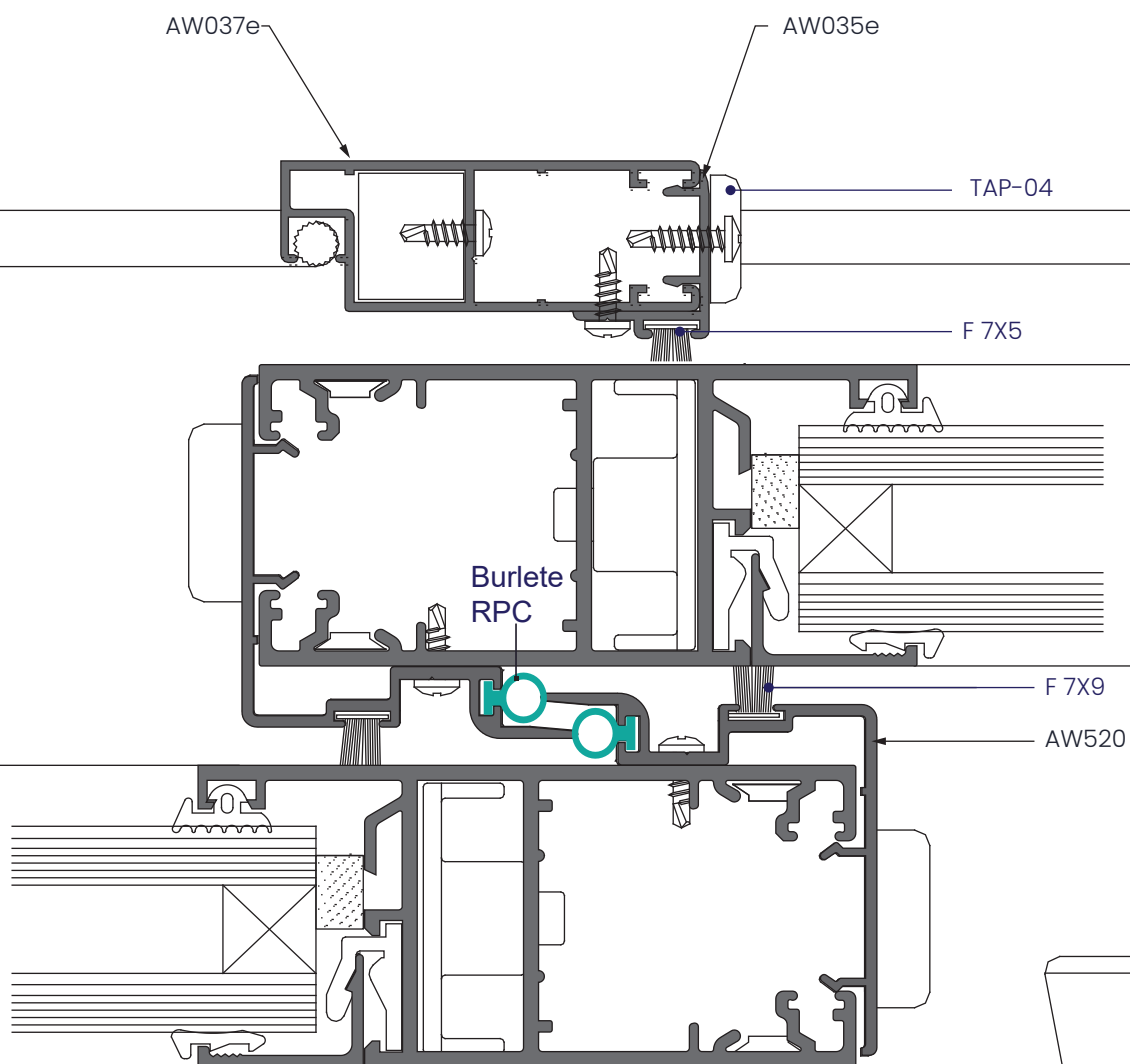

### Sección 1

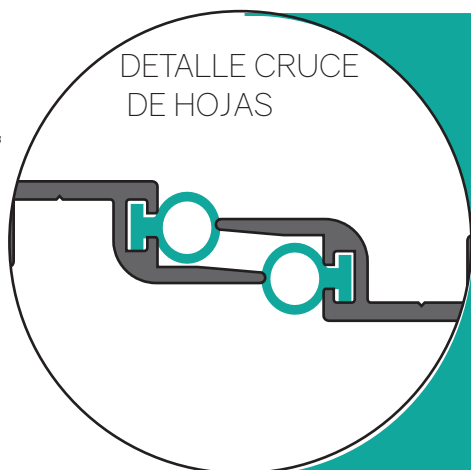

DETALLE CRUCE DE HOJAS



Nota: Es indispensable utilizar SIEMPRE el burlete RPC a lo largo del perfil AW520. Se puede utilizar también para brindar hermeticidad en las jambas, a lo largo del perfil AW 571.

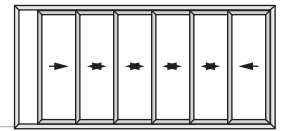

### DETALLE / CIERRE LATERAL CON FALLEBA Y MULTIPUNTO

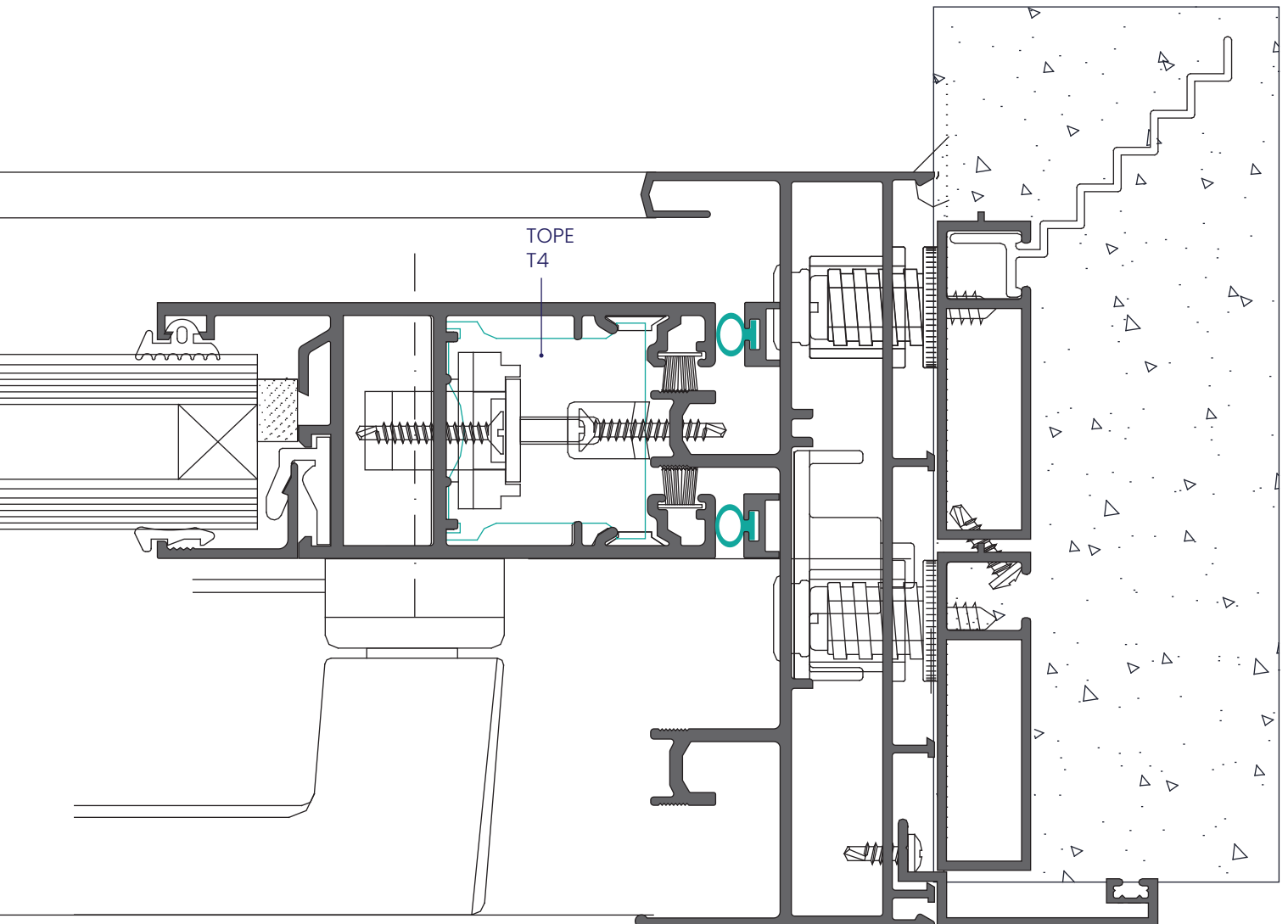

### Sección 1

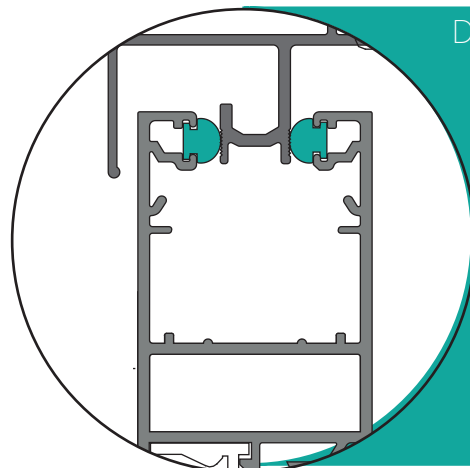

#### DETALLE ANTIVIBRACION

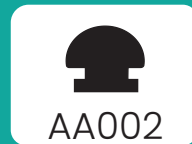

Nota: Es indispensable utilizar SIEMPRE el patin AA002 en el extremo de las jambas para evitar vibraciones en las hojas. Llevan 8 por abertura

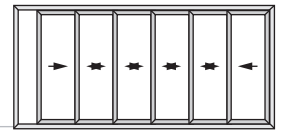

### DETALLE / GUÍA DE MARCO SUPLEMENTARIA

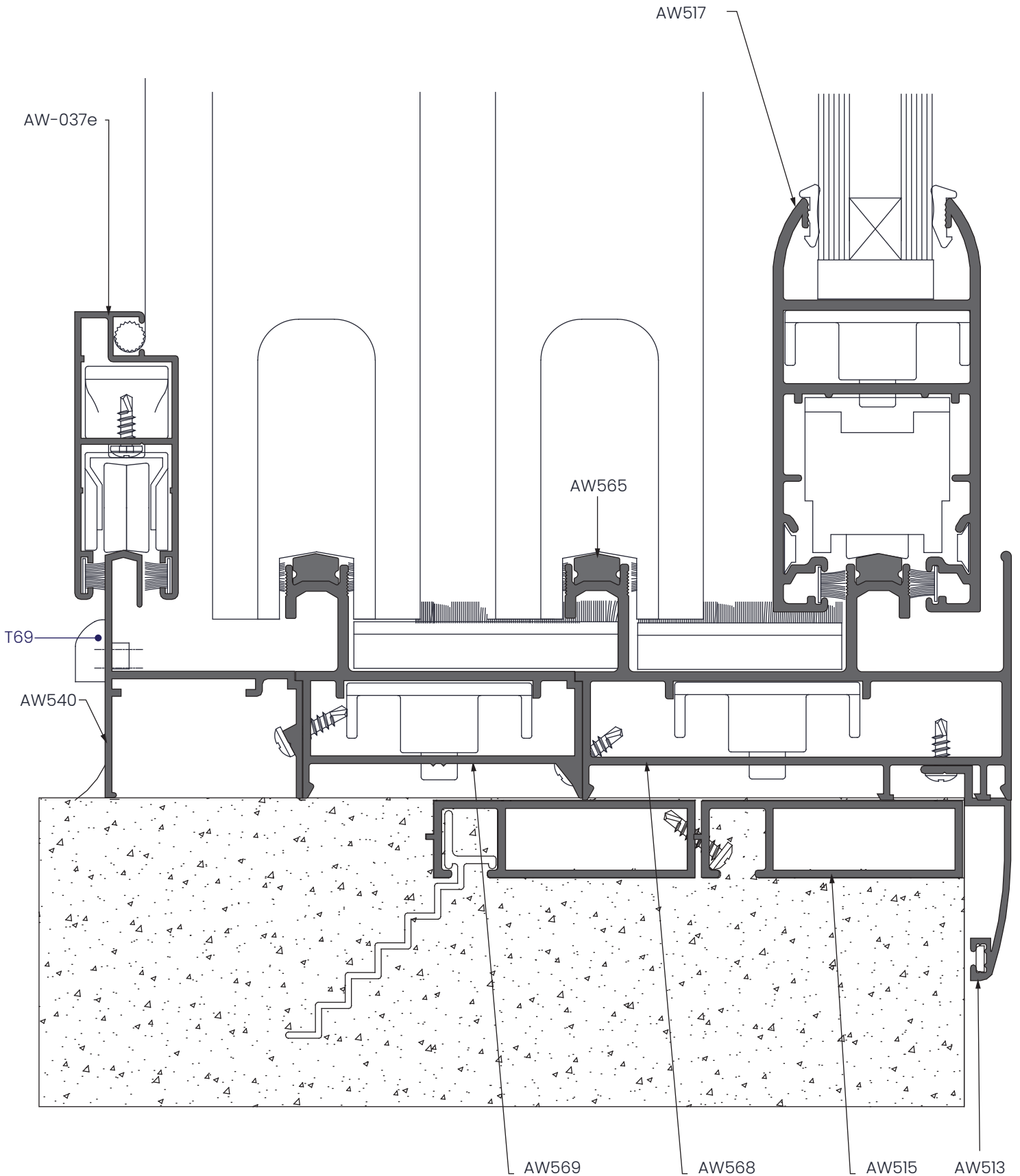

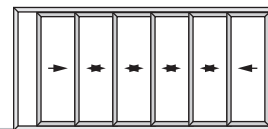

### DETALLE / CRUCE DE HOJAS CON REFUERZO

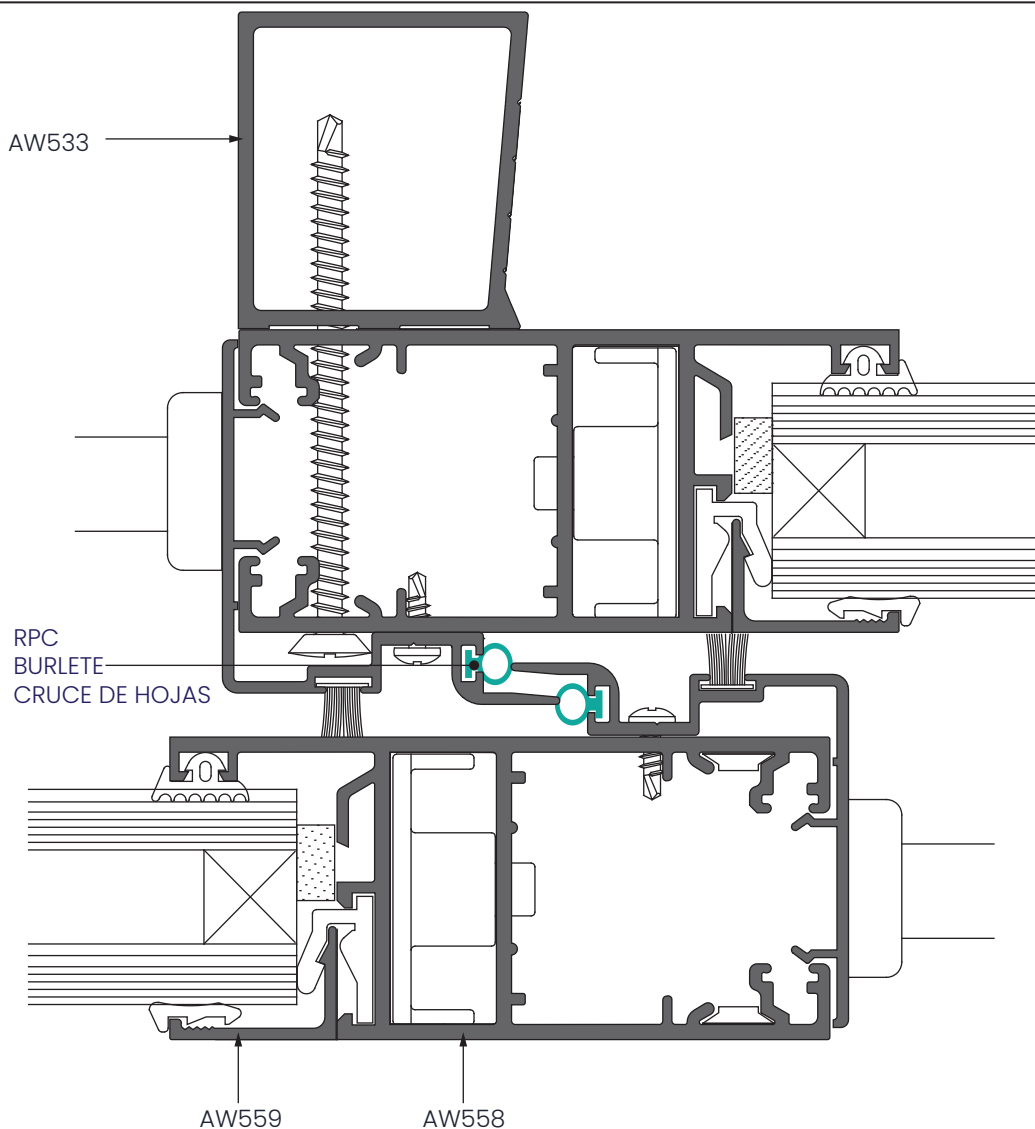

### DETALLE / ENCUENTRO CENTRAL

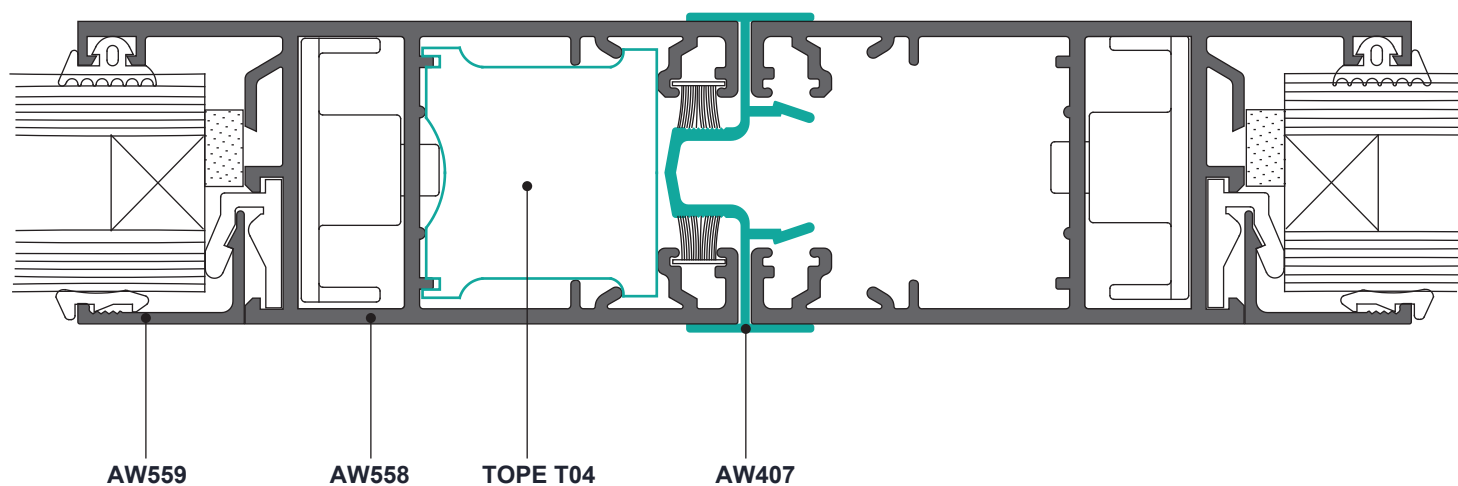

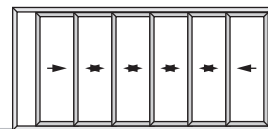

DETALLE / ACOPLAMIENTO INTERIOR DE MARCO EN ABERTURA MAYOR A 6,2 M

### GUIAS ACOPLABLES

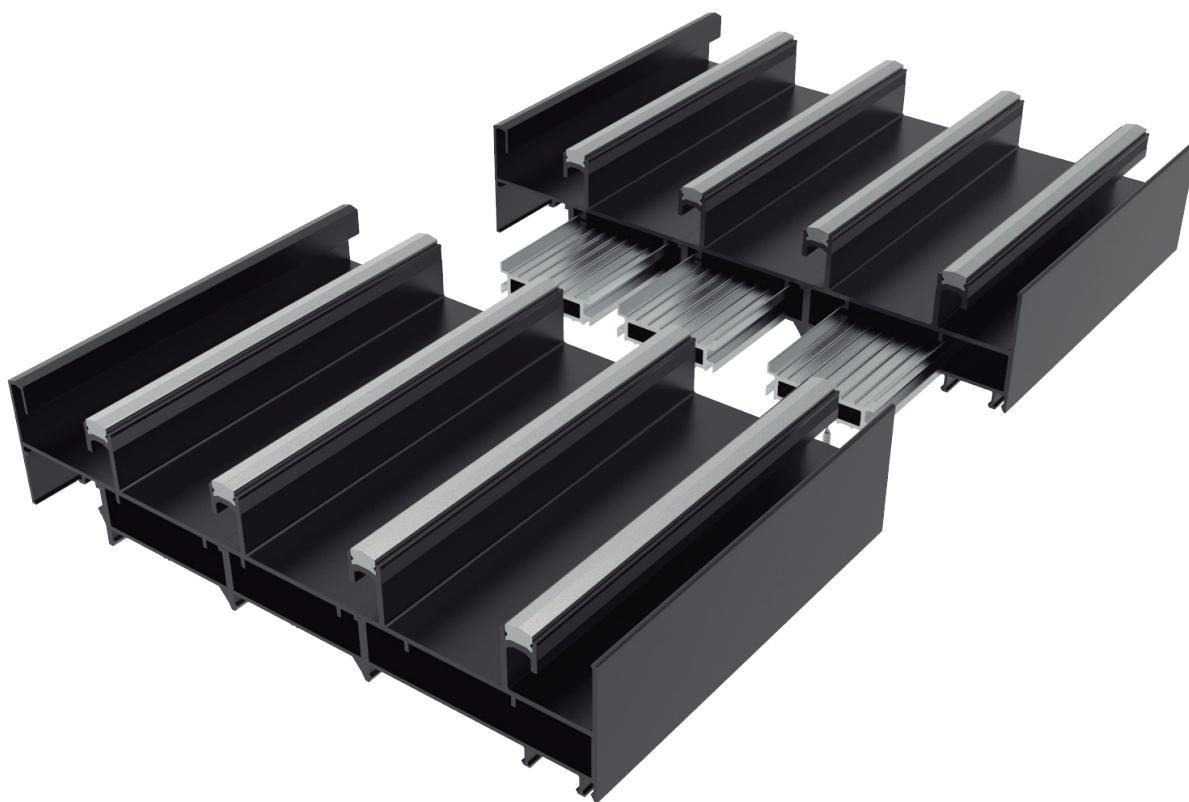
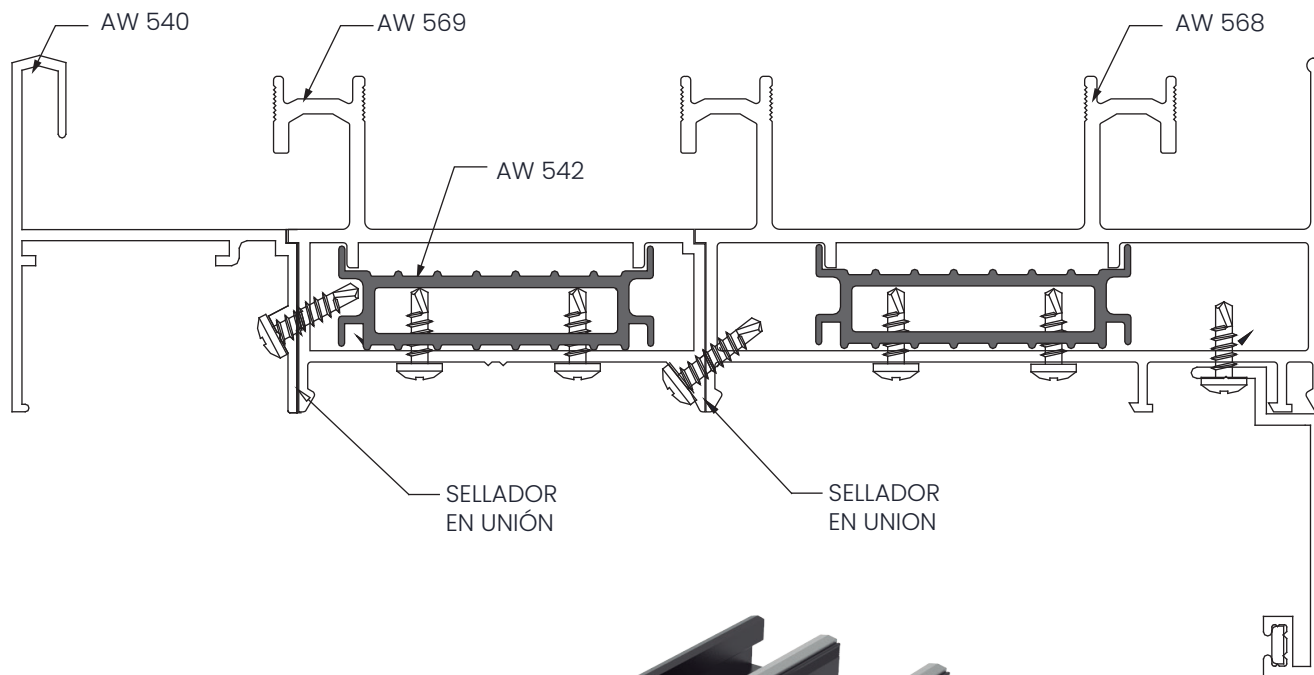

**IMPORTANTE:** Para hojas corredizas que superan los 80kg se recomienda el uso del perfil de refuerzo interno AW542.

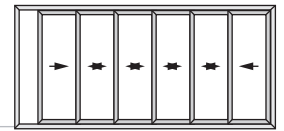

### DETALLE ACOPLE A 90° RECTO

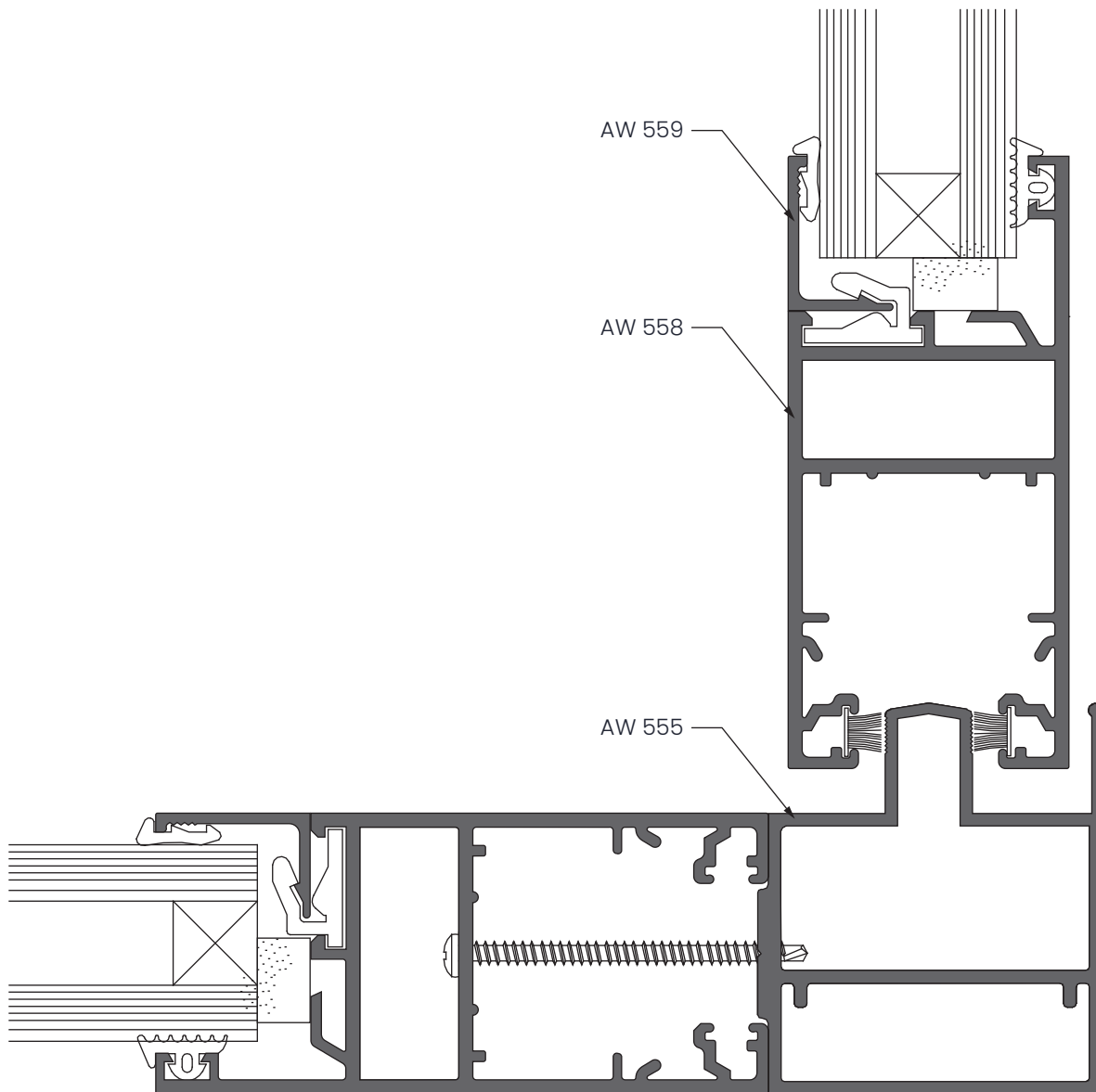

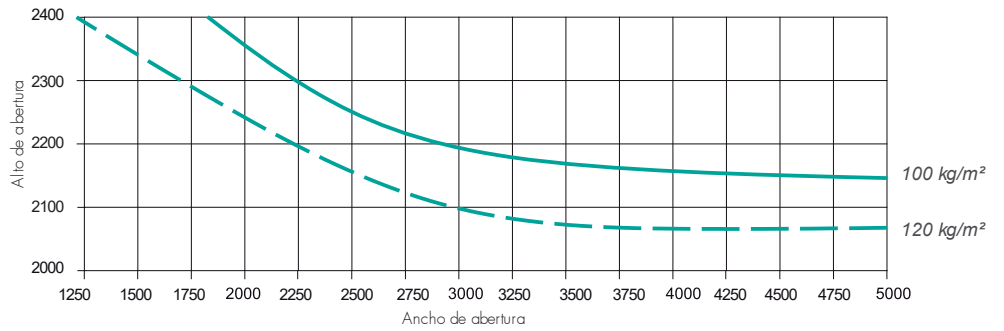
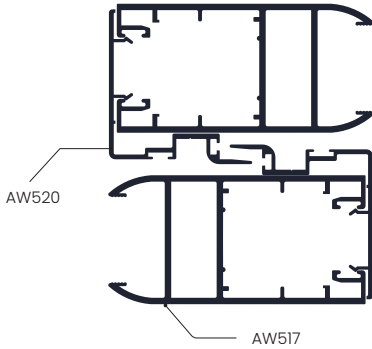
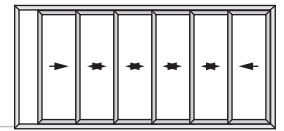

\* Valores Alto/Ancho de aberturas expresados en milímetros

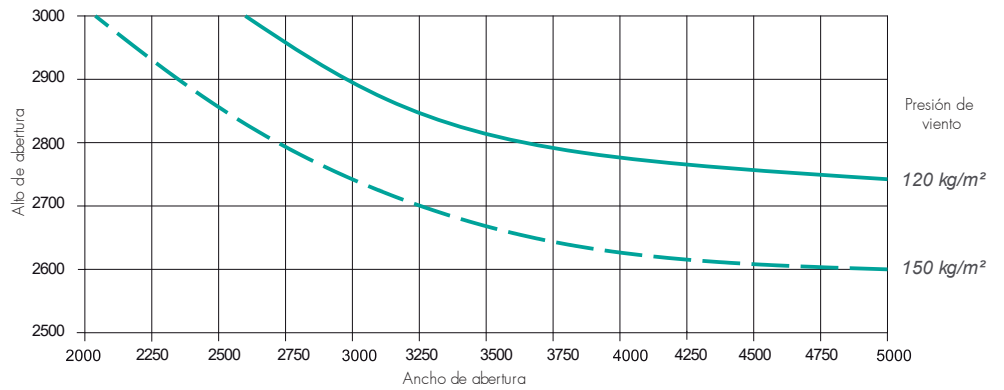
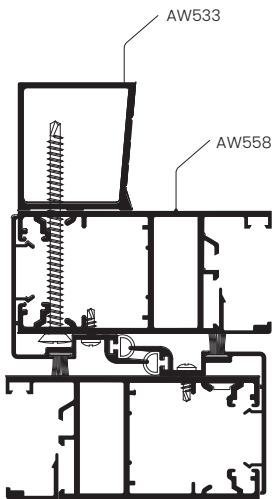

\* Valores Alto/Ancho de aberturas expresados en milímetros

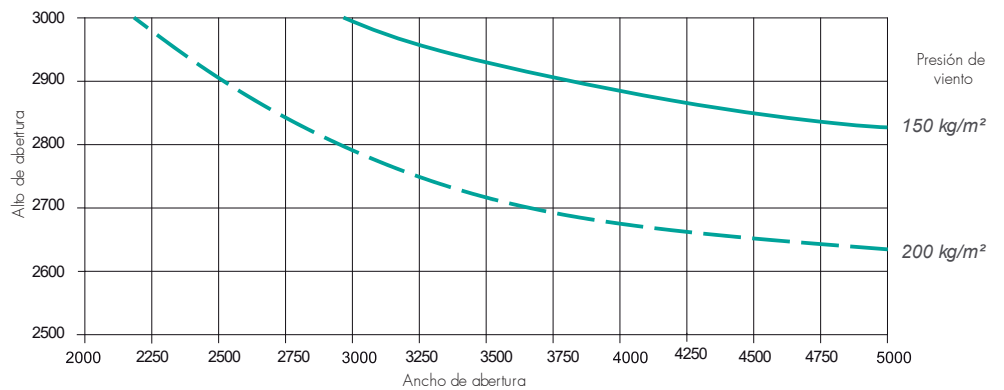
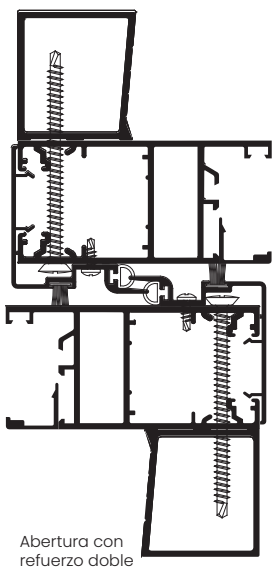

\* Valores Alto/Ancho de aberturas expresados en milímetros

Nota: para hojas de gran tamaño o muy pesadas siga las recomendaciones de su proveedor de ruedas