



Desarrollos únicos que son tendencia

Última actualización 16/10/2025



PUERTAS Y VENTANAS CORREDIZAS RPT
MANUAL TÉCNICO



 (0351)695 7920  aluwind.com.ar    AluwindSA











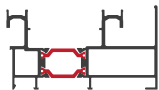

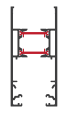

 Av. Japón 550 - Córdoba, Argentina

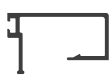













INDICE	PÁGINA
Ventana Corrediza a 45°	03
Perfiles esc.1:1	08
Descuentos	12
Listado de accesorios	13
Ventana de Rebatir / Oscilobatiente / Banderola	20
Perfiles esc.1:1	23
Descuentos	25
Listado de accesorios	26
Detalle contravidrios	30
Ventana Desplazable	31
Perfiles esc.1:1	34
Descuentos	35
Listado de accesorios	36
Detalle contravidrios	38
Puerta de Rebatir	39
Perfiles esc.1:1	42
Descuentos	44
Listado de accesorios	46
Detalle contravidrios	49
Detalle contravidrios	49
Paño Fijo	51
Perfiles esc.1:1	54
Descuentos	55
Listado de accesorios	56
Detalle contravidrios	57



CORREDIZAS 45°

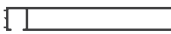

CÓDIGO	DESCRIPCIÓN	PESO Kg/m	FORMA	L. Std.
C 3002 i	Guía doble corrediza	1,685		6,20
C 3004 i	Guía doble corrediza con mosquitero	2,151		6,20
C 3006 i	Hoja corrediza	1,851		6,20
AW 3007	Cruce de hojas	0,541		6,20
C 3010 i	Guía corrediza y paño fijo (AW 3008+AW 3009)	1,667		6,20
C 3013 i	Travesaño para corrediza con Paño fijo	1,827		6,20
AW 3014	Cruce de hoja y paño fijo	0,330		6,20
AW 3015	Contravidrio para paño fijo y corrediza	0,363		6,20
AW 540	Guía Mosquitero (acoplable)	0,479		6,20
AW 569	Marco corrediza una guía (acoplable)	0,887		6,20
AW 565	Guía postiza (anodizada)	0,115		6,20
AW 592	Cruce SLIM reforzado	1,769		6,20
AW 593	Cruce SLIM sin refuerzo	0,770		6,20
AW 037e	Hoja mosquitero	0,529		6,20
AW 590	Hoja mosquitero con portafelpa	0,616		6,20

CÓDIGO	DESCRIPCIÓN	PESO Kg/m	FORMA	L. Std.
AW 566	Travesaño Mosquitero	0,486		6,20
AW 567	Refuerzo Mosquitero	0,470		6,20
AW 035e	Tapa Hoja mosquitero AW 037e	0,166		6,20
AW 555	Acople a 90° Guía simple corrediza 1 hoja	1,33		6,20
AW 533	Refuerzo hoja corrediza	0,827		6,20
AW 514	Tapajuntas	0,257		6,20
AW 553	Contra vidrio recto a 45° de 4 mm	0,141		6,20
AW 6220	Contra vidrio recto a 90° de 5 mm	0,179		6,20
AW 407	Encuentro central	0,47		6,20
AW 515	Premarco 50 mm	0,52		6,20
AW 564	Premarco 68mm	0,564		6,20
AW 596	Premarco corrediza 3 hojas	0,993		6,20
AW 571	Portaburlete Tope de hoja	0,115		6,20
AW 542	Union interior de guías corredizas	0,424		6,20

PERFILES PVC

CÓDIGO	DESCRIPCIÓN	PESO Gr/Cm3	FORMA	L. Std.
AW PVC1	Perfil PVC para cruce de hojas corredizas	0,074		6.20
AW PVC2	Perfil PVC para marcos corredizas	0,080		6.20
AW PVC3	Perfil PVC para marco corrediza y paño fijo	0,049		6.20



IMPERIA

RPT+



Perfiles Escala 1:1

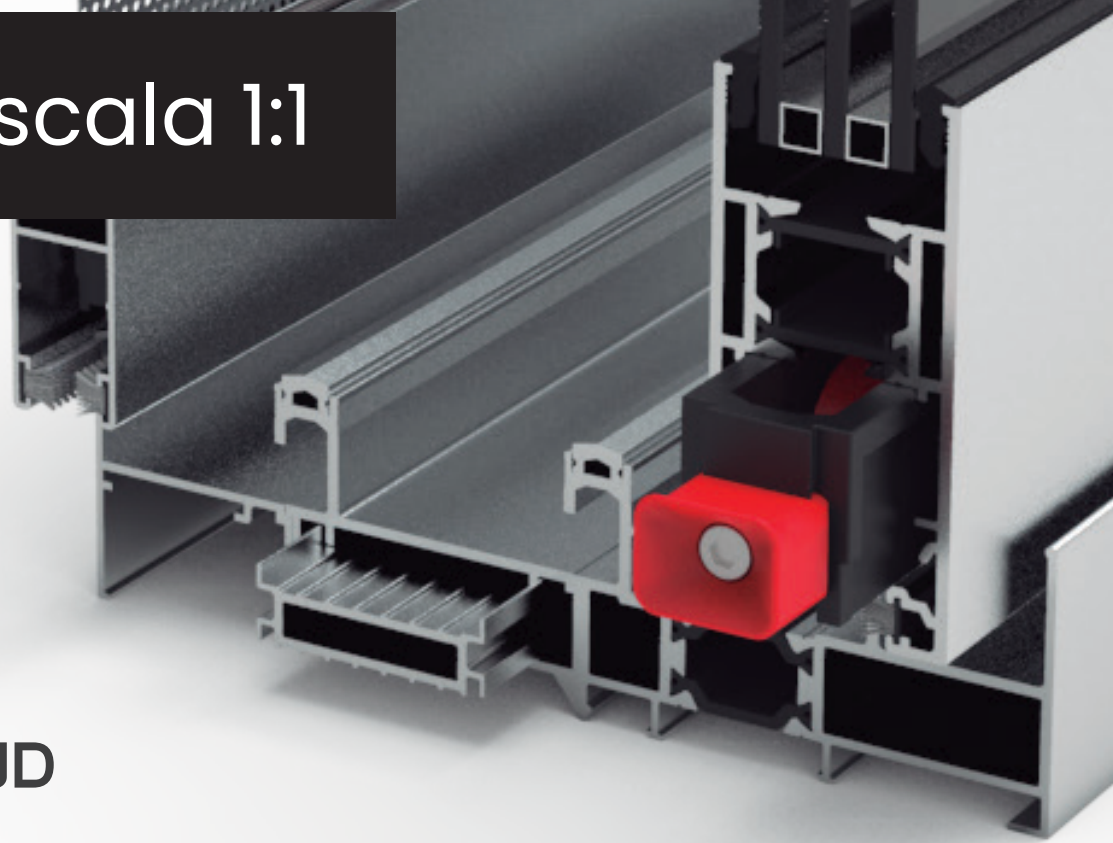

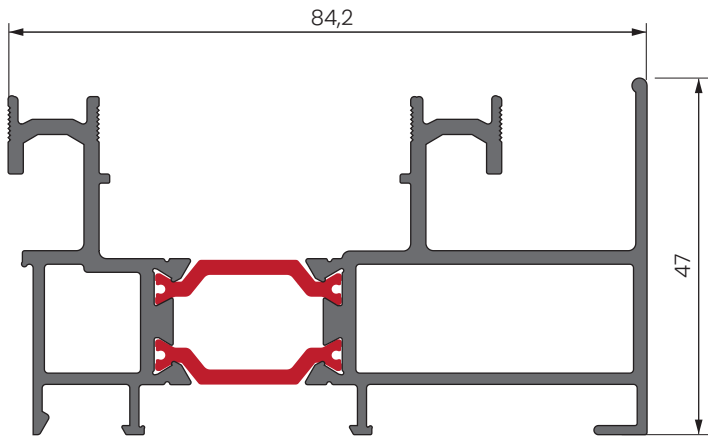

C3002i

Guía doble corrediza
1,685 Kg/m



AW PVC2

Perfil para marcos corredizas
0,080 kg/m

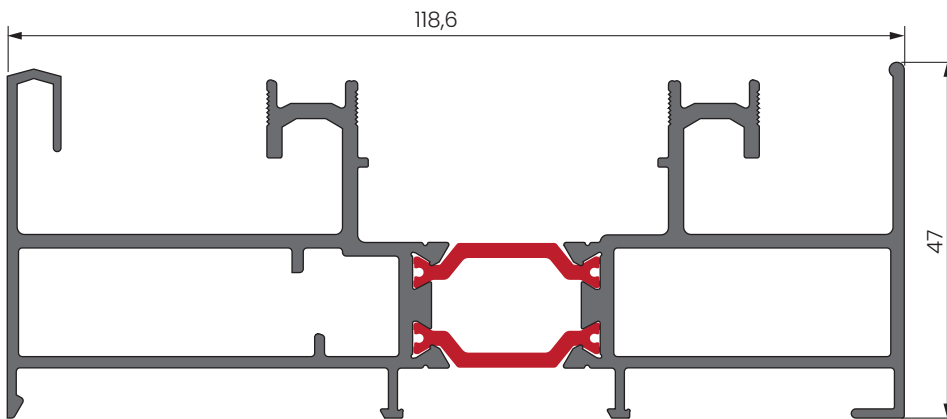

C3004i

Guía doble corrediza con mosquitero
2,151 Kg/m

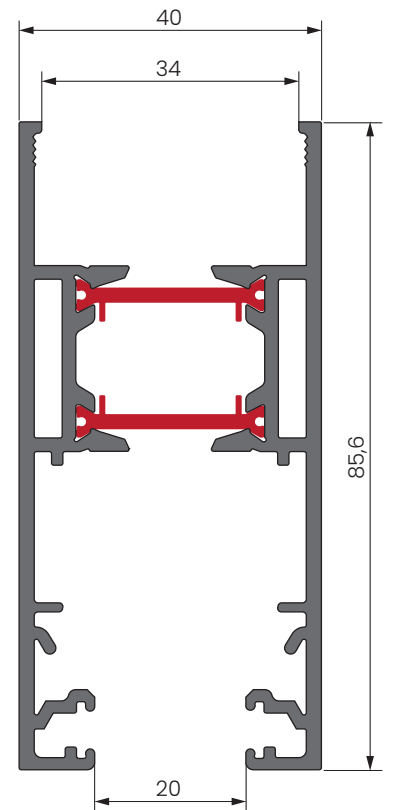

C 3006 i

Hoja a 45° para dvh
1,851 kg/m

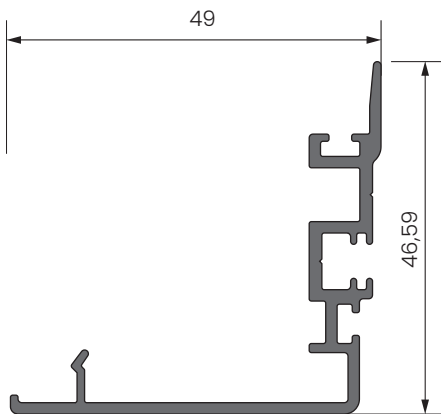

AW 3007

Cruce de hoja
0,541 Kg/m

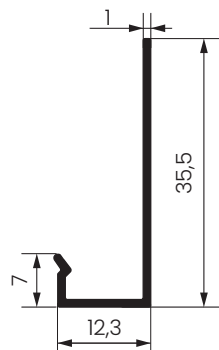

AW PVC1

Perfil para cruce de hojas
0,074 Kg/m

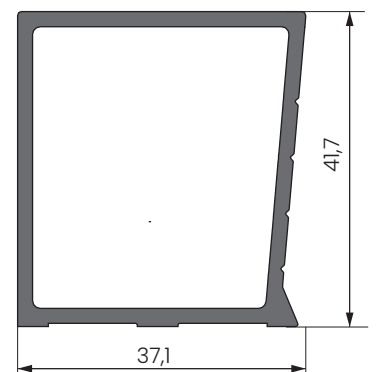

AW 533

Refuerzo
0,830 Kg/m

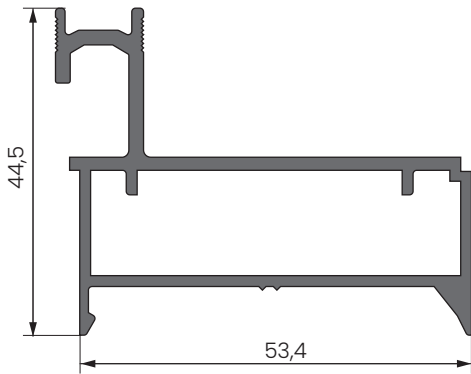

AW 569

Marco corrediza una guía (acoplable)
0,888Kg/m

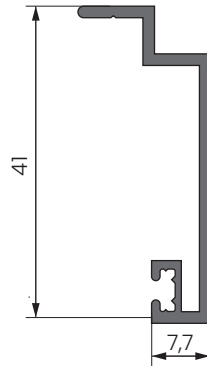

AW 514

Tapajuntas recto
0,280 Kg/m

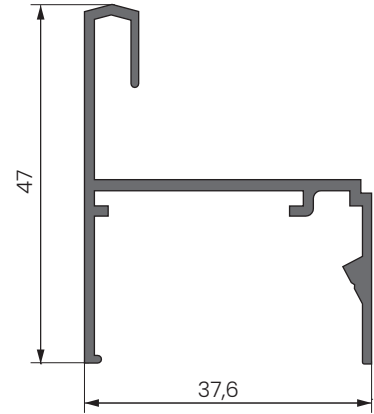

AW 540

Guía de mosquito (acoplable)
0,479 Kg/m

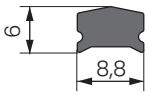

AW 565

Guía postiza
(anodizada)
0,115 Kg/m

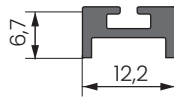

AW 571

Tope hoja corrediza
0,115 Kg/m

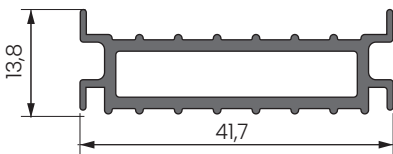

AW 542

Union interior de guías
0,424Kg/m

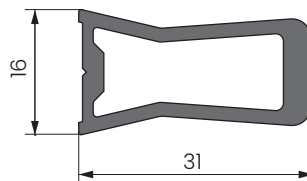

AW 567

Refuerzo mosquitero
0,470 Kg/m

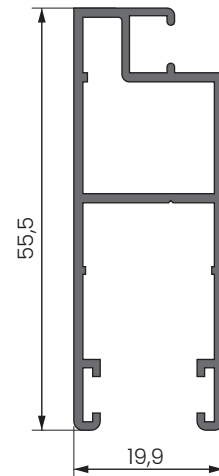

AW 037e

Hoja mosquitero
0,529 Kg/m

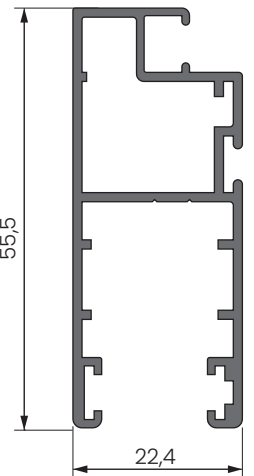

AW 590

Hoja mosquitero
Con portafelpa
0,616 Kg/m

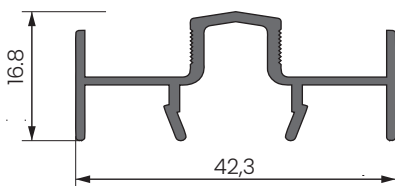

AW 407

Encuentro central
0,470 Kg/m

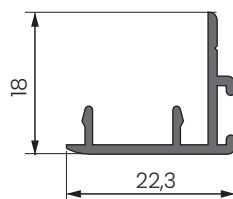

AW 035e

Tapa hoja mosquitero
0,522 Kg/m

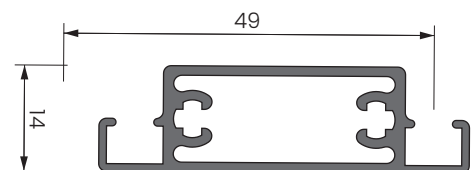

AW 566

Travesaño mosquitero
0,486 Kg/m

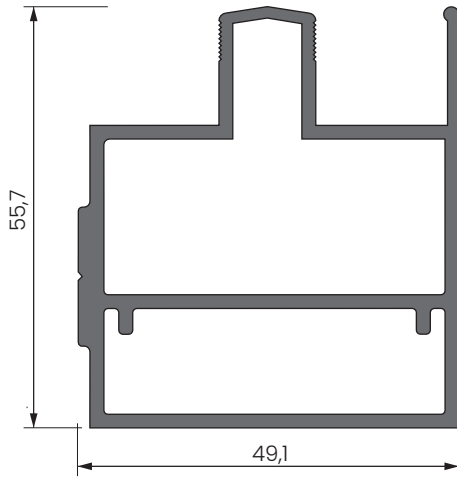

AW 555

Acople a 90° recto - Guía corrediza 1 hoja
1,201 Kg/m

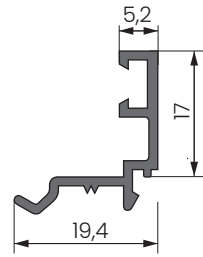

AW 6220

Contravidrio de 5mm
0,179 Kg/m

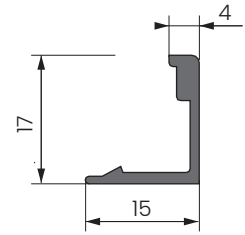

AW 553

Contravidrio de 4mm
0,141 Kg/m

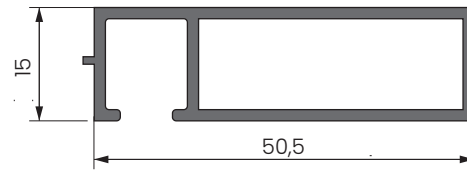

AW 515

Premarco 50mm
0,523 Kg/m

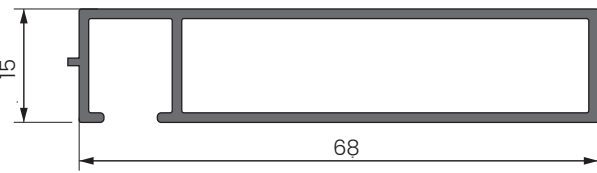

AW 564

Premarco 68mm
0,564 Kg/m

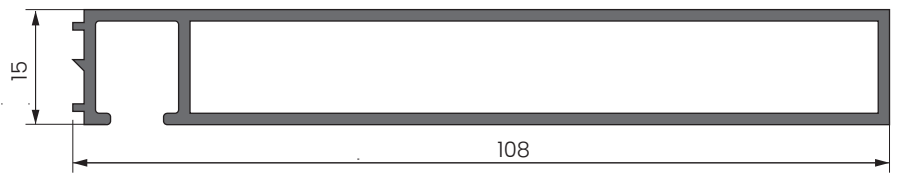

AW 596

Premarco 108mm, corrediza 3 guías
0,993 Kg/m

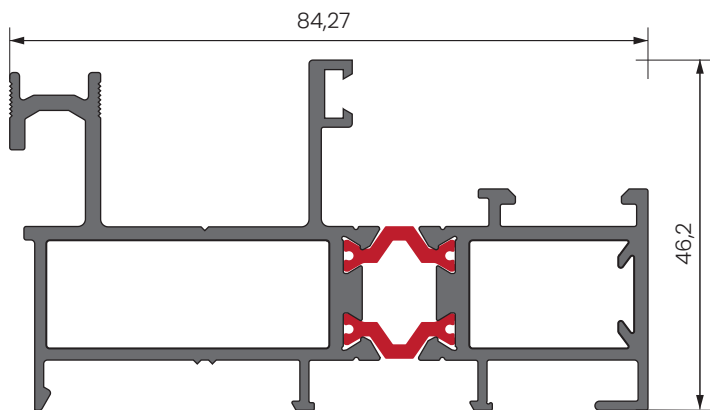

C 3010 i

Guía corrediza y paño fijo
1,667 Kg/m

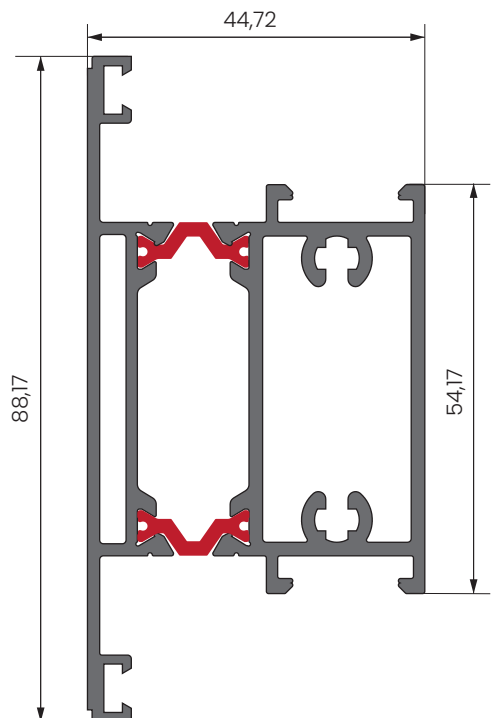

C 3013 i

Travesaño para guía corrediza
y paño fijo -1,827 Kg/m

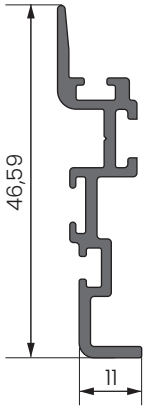

AW 3014

Cruce corrediza
y paño fijo -0,330 Kg/m

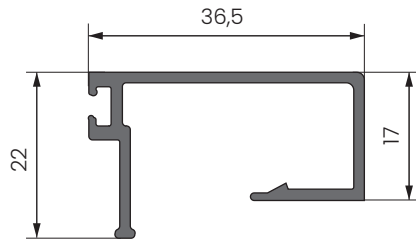

AW 3015

Contravidrio corrediza
y paño fijo -0,363 Kg/m

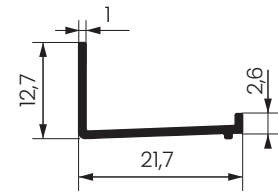

AW PVC3

Perfil para marco corrediza
y paño fijo -0,049 Kg/m

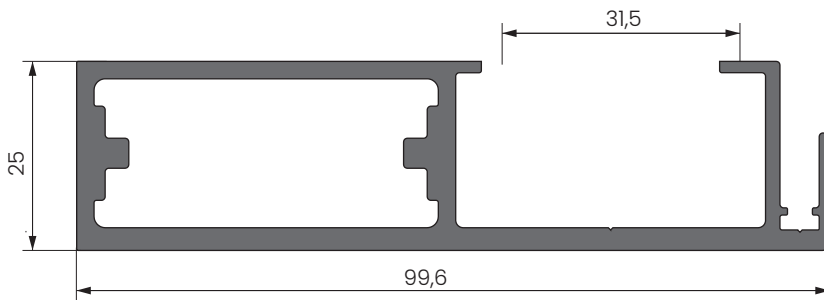

AW 592

Cruce slim DVH con refuerzo
1,844 Kg/m

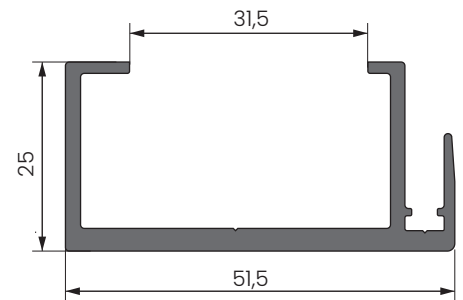

AW 593

Cruce slim DVH
0,845 Kg/m

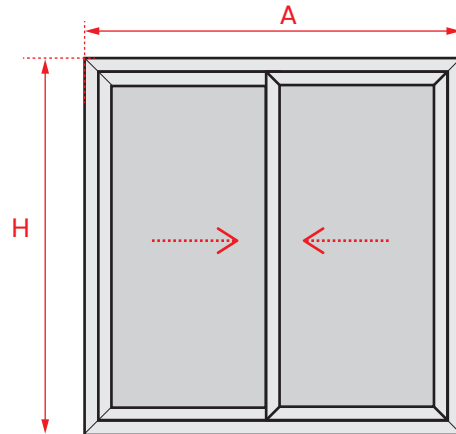
DESCUENTOS

Descuentos en perfiles

CANT.	PERFIL	MEDIDA	DESCRIPCIÓN	CORTE
2	AW-515	A+36	Premarco dintel y zocalo	45° - 45°
2	AW-515	H+18	Premarco jambas	45° - 45°
2	AW-3025	A+70	Dintel y zocalo tapajuntas recto	45° - 45°
2	AW-3025	H+35	Jambas tapajuntas recto	45° - 45°
2	C3002i / C3004i	A y H	Marco	45° - 45°
2	AW-565	A - 84	Sombrilla para guía de marco	90°
4	AW-571	H - 48	Portaburlete tope de hoja	90°
4	C 3006 i	(A/2)+5	Dintel y zocalo hoja (2 hojas y 2 guias)	45° - 45°
6	C 3006 i	(A/3)+31	Dintel y zocalo hoja (3 hojas y 3 guias)	45° - 45°
4	C 3006 i	(A/2)+44	Dintel y zocalo hoja (4 hojas y 4 guias)	45° - 45°
6	C 3006 i	(A/3)+52	Dintel y zocalo hoja (5 hojas y 5 guias)	45° - 45°
4	C 3006 i	H-73	Jambas hoja	45° - 45°
2	AW-3007	H-73	Perfil encuentro de hojas	90°
2	AW-037e	(A/2)+7	Dintel y zocalo hoja mosq. (2 hojas y 2 guias)	45° - 45°
2	AW-037e	(A/3)+33	Dintel y zocalo hoja mosq. (3 hojas y 3 guias)	45° - 45°
2	AW-037e	H-74	Jambas hoja mosquitero	45° - 45°
2	AWT-540	A Y H	Guia mosquitero	45° - 45°
1	AWT-035e	H-74	Tapa hoja de mosquitero	90°

Descuentos en vidrios

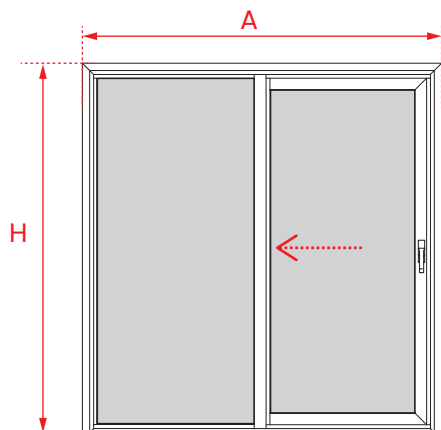
CANT.	TIPO	ANCHO	ALTO	DESCRIPCIÓN	HOJA
1	DVH	[(A/2)+4]-150	(H-74)-150	DOBLE VIDRIADO HERMÉTICO	C 3006 i

DESCUENTOS

EN REVISIÓN
Descuentos en perfiles

CANT.	PERFIL	MEDIDA	DESCRIPCIÓN	CORTE
2	AW-564	A+36	Premarco dintel y zocalo	45° - 45°
2	AW-564	H+18	Premarco jambas	45° - 45°
2	AW-514	A+70	Dintel y zocalo tapajuntas recto	45° - 45°
2	AW-514	H+35	Jambas tapajuntas recto	45° - 45°
4	C3010i	A y H	Marco	45° - 45°
1	AW-565/AW PVC 3	A - 84	Sombrilla para guía de marco y aw pvc 3	90° - 90°
1	AW-571	H - 48	Portaburlete tope de hoja	90° - 90°
2	C 3006 i	(A/2)+5	Dintel y zocalo hoja (1 hoja y 1 guia)	45° - 45°
4	C 3006 i	H-73	Jambas hoja	45° - 45°
1	C 3013 i	H-58	Travesaño paño fijo	90° - 90°
1 / 1	AW-3007/AW-PVC1	H-73	Perfil cruce de hojas y aw pvc1	90° - 90°
1	AW-3014	H-92	Perfil cruce de travesaño	90° - 90°
2 / 2	AW-3015 / AW 6220	(A/2)-56	Dintel y zocalo contravidrio paño fijo	90° - 90°
2 / 2	AW-3015 / AW 6220	H-92	Jambas contravidrio paño fijo	90° - 90°
2	AW-037e	(A/2)+5	Dintel y zocalo hoja mosq.	45° - 45°
2	AW-037e	H-75	Jambas hoja mosquitero	45° - 45°
4	AW-540	A Y H	Guia mosquitero	45° - 45°
1	AW-035e	H-73	Tapa hoja de mosquitero	90° - 90°

Descuentos en vidrios - Corrediza

CANT.	TIPO	ANCHO	ALTO	DESCRIPCIÓN	HOJA
1	DVH	(A/2)-144	H-221	DOBLE VIDRIADO HERMÉTICO	C 3006 i

Descuentos en vidrios - Paño fijo

1	DVH	(A/2)-68	H-70	DOBLE VIDRIADO HERMÉTICO	C 3010 i / C 3013 i
---	-----	----------	------	--------------------------	---------------------

DESCRIPCIÓN	IMAGEN	CODIGO	CANT. POR ABERTURA	MARCA
TOPE PARANTE LATERAL (tope de hojas con marco) <i>Venta por unidad</i>		TOPE T4	4	ALUWIND PEDIDOS WEB!
BURLETE CRUCE DE HOJAS A 45°/ CIERRE HERMETICO JAMBAS <i>Venta por rollos de 100m</i>		RPC	Toda la longitud encuentro AW3007	ALUWIND PEDIDOS WEB!
ANTIVIBRACION / PATIN <i>Paquete por 100 unidades</i>		AA-002	8	ALUWIND PEDIDOS WEB! MONPAT
BURLETE CRUCE / CIERRE HERMETICO JAMBAS <i>Venta por rollos de 50m</i>		I-62	longitud del perfil AW573-AW574	ALUWIND PEDIDOS WEB!
TAPA SUPERIOR E INFERIOR PARA COLUMNA EN ESQUINA AW555 <i>Paquete por 2 unidades</i>		T555B (blanco) T555N (negro) T529G (gris)	1 par	ALUWIND PEDIDOS WEB!
TAPA SUPERIOR PARA CRUCE SLIM <i>Paquete por 10 unidades</i>		TA73 (anodizada) TA73N (negro)	1	ALUWIND PEDIDOS WEB!
CAJA VINCULADORA HOJA/ CRUCE <i>Paquete por 10 unidades</i>		CJ-02	1	ALUWIND PEDIDOS WEB!
ESCUADRA DE PREMARCOS		E78	4	MONPAT
ESCUADRA DE ALINEACION TAPAJUNTAS		AA-107	2	MONPAT
ESCUADRA ARMADO HOJAS MOSQUITERO		AA-300	4	MONPAT
ESCUADRA DE ALINEAMIENTO DE HOJA		E-66	16	TANIT
ESCUADRA DE HOJA		AA-003 / E-83	12	TANIT
ESCUADRA ARMADO MARCOS			4	
RUEDA REGULABLE DOBLE		R-47	4	GIESSE - ROTO PABOSE
RUEDA MOSQUITERO		615951	4	ROTO FRANK
		CARRO TRIESTE		MONPAT
TOPE PARANTE CENTRAL		T-118	4	MONPAT
TACO REGULADOR		T-88	-	FRIUL TRADE
TOPE MOSQUITERO/ANTI RUIDO		T-90	4	MONPAT
CONTRAVIENTO		AA-209	4	MONPAT
BURLETE CUERDA MOSQUITERO		B-9	-	LIGOM
BURLETE CUÑA		B29 / B30 / B31	-	LIGOM

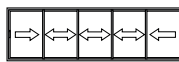





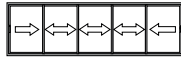

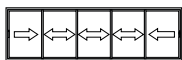

DESCRIPCIÓN	IMAGEN	CODIGO	CANT. POR ABERTURA	MARCA
CLAPETA MOSQUITERO		T-69	2 por metro	TANIT
FELPA CON FIN SEAL 7X7		7X7	-	MONPAT
FELPA HOJA MOSQUITERO 7X4.5		7X4,5	-	MONPAT
FELPA CRUCE MOSQUITERO 7X5		7X5	-	MONPAT

	DESCRIPCIÓN	IMAGEN	CODIGO	CANT. POR ABERTURA	MARCA
	Falleba Rotoline		Blanco (cod.490545)	2	ROTO FRANK
			Negro (cod.490546)		
Gris (cod.339532)					
Falleba Rotoline con CERRADURA		Blanco (cod.228043)	2		
		Gris (cod.228040)			
Kit falleba acodada	Falleba multipunto acodada (izquierda y derecha)		Acodada DERECHA Blanca (cod.375816)	2	
			Acodada DERECHA Negro (cod.570511)		
			Acodada DERECHA Gris (cod.375814)		
			Acodada IZQUIERDA Blanco (cod.375320)		
			Acodada IZQUIERDA Negro (cod.570510)		
	Acodada IZQUIERDA Gris (cod.375319)				
Cuadradillo para falleba acodada		287824	2 (1 cuadradillo por cada falleba acodada)		
Kit de manijon para interior	Tirador, ventana corrediza Interior (manijon interior)		Blanco (cod.613226)	2	
			Negro (cod.613225)		
			Gris (cod.613222)		
Kit de tornillos y cuadradillo		613181 1 kit - incluye: Tornillos para manijon (3) Cuadradillo de bronce (1)	2 (1 kit por cada manijon)		







	DESCRIPCIÓN	IMAGEN	CODIGO	CANT. POR ABERTURA	MARCA
Kit de manijon para Exterior (opcional)	Tirador, ventana corrediza Interior (manijon interior)		Blanco (cod. 613191)	2	ROTO FRANK
			Negro (cod. 613190)		
Gris (cod. 613187)					
	Kit de tornillos y cuadradillo		613181 1 kit - incluye: Tornillos para manijon (3) Cuadradillo de bronce (1)	2 (1 kit por cada manijon)	
Kit uñero pop-up de embutir	Uñero multipunto embutir con pop-up (trae cuadradillo de bronce incluido)		Blanco (cod. 570810)	2	
			Negro (cod.614295)		
	Gris (cod.637963)				
	Tornillos para uñero (2 tornillos por uñero)		490 014T Tornillos para uñero (2)	2 (1 kit por cada uñero)	
	Cierre multipunto		Mecanismo de 600mm (cod. 628484)	2	
			Mecanismo de 1800mm (cod. 628498)		
	Cerradero		834431 en mecanismo de 600mm. Sin prueba 478413. Lleva suplemento plastico	2	
			834431 en mecanismo de 1800mm. Sin prueba practica 478413. Lleva suplemento plastico	4	
	Anti Falsa maniobra		343733	1	
	Suplemento plastico para multipunto		564313 Mecanismo de 600mm	3	
			564313 Mecanismo de 1800mm	5	
			491665 Mecanismo de 600mm	3	
491665 Mecanismo de 1800mm			5		

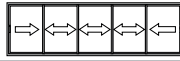

DESCRIPCIÓN	IMAGEN	CODIGO	CANT. POR ABERTURA	MARCA
CIERRE MULTIPUNTO CHAMPION PLUS EN REVISIÓN		02725 (600MM) 02726 (1000MM) 06310 (1600MM) 02728 (1800 c/ cerradero)	2	Cierre MULTIPUNTO
KIT IMPERIA		06482 (2 puntos) 06483 (3 puntos)	2	
MARTELINA PRIMA		02762	2	
MARTELINA KORA		00997		
MARTELINA ASIA		02415		
UÑERO EXT.		02764		
ANTI FALSA MANIOBRA		02770	2	Cierre LATERAL
CIERRES BRIO		02992N (brio) 02983N (brio plus) 02892N (brio key) 02988N (brio mini)	2	
KIT IMPERIA		05005	2	
FLECHA		02597	2	
GANCHO		03336	2	

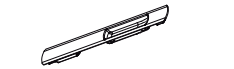

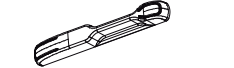
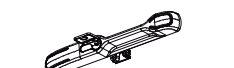
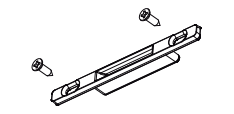
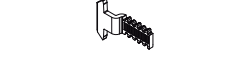
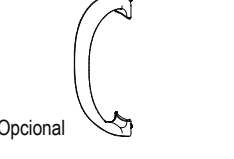
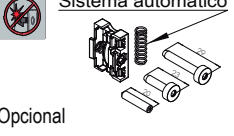
DESCRIPCIÓN	IMAGEN	CODIGO	CANT. POR ABERTURA	MARCA
GANCHO DE MARCO EMBUTIDO CIERRE OLE TOP		5003AA 5003AB	2	FAPIM para CORREDIZA A 45°
CIERRE OLE TOP		5003CA 5003CB	2	
CIERRE OLE TOP CON LLAVE		5004AA 5004AB	2	
CUBETA EXTERIOR		5013	2	
CUBETA EXTERIOR CON LLAVE		5014	2	
TIRADOR EXTERIOR		5015	2	
TIRADOR EXTERIOR CON LLAVE		5016	2	
CERRADERO		5032A	2	
GANCHO		5023NA	2	
TIRADOR INTERIOR	 Opcional	5010B	2	
ANTI-FALSA MANIOBRA	 Opcional	5020 B	2	

EN REVISIÓN

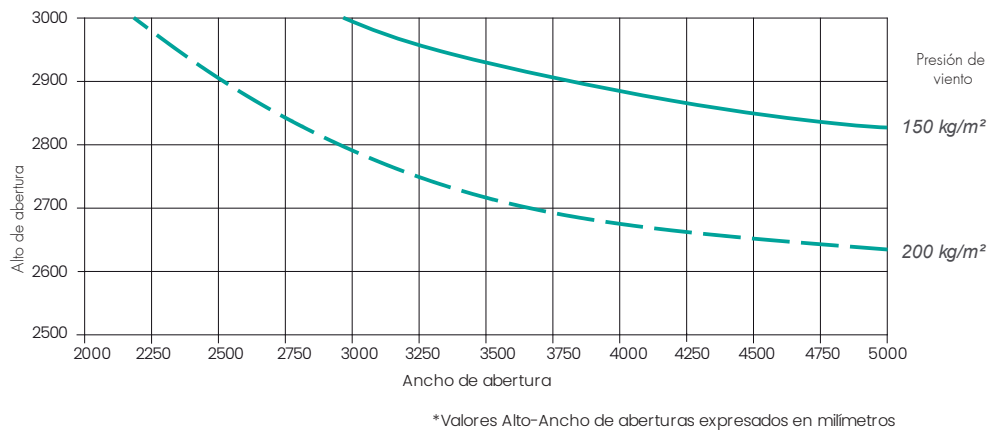
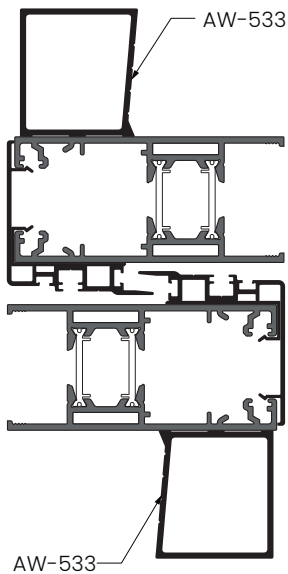
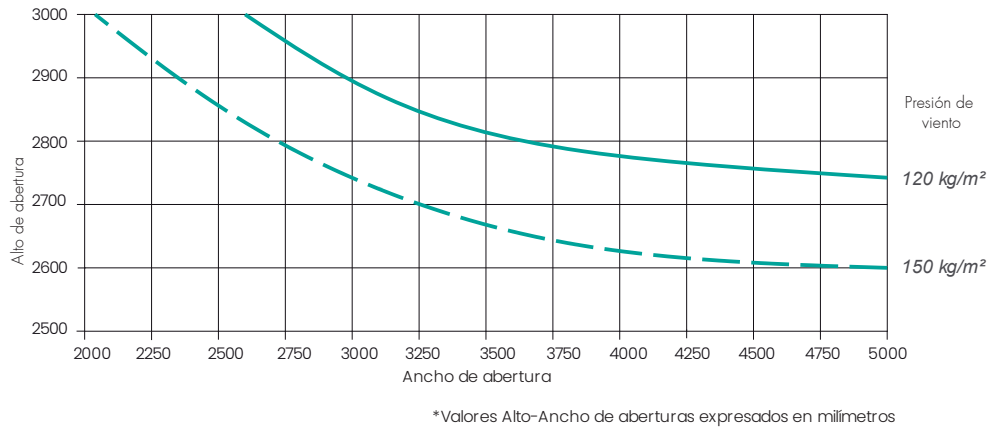
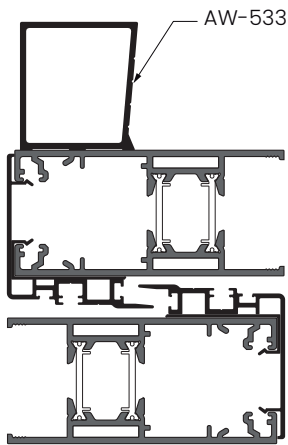
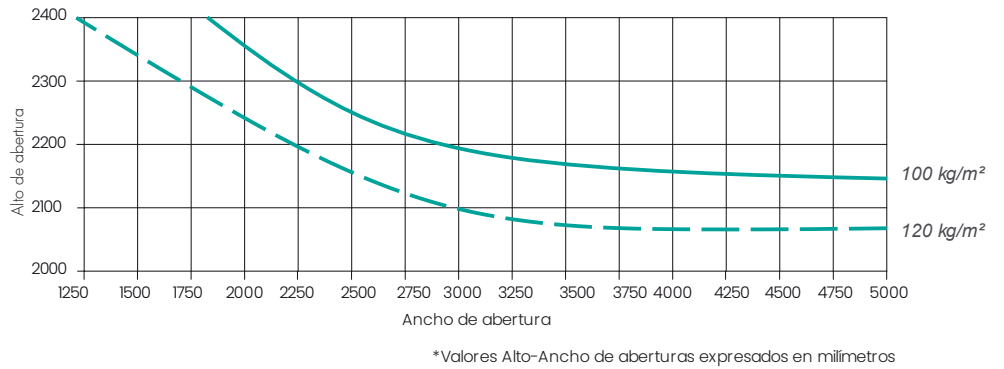
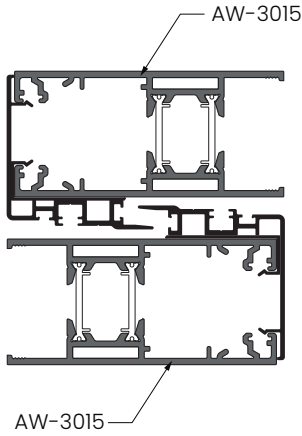
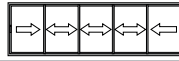

Abertura con refuerzo doble

Tu Perfil

Peso máximo de las hojas (valores estimativos):
 Con ruedas simples R46: 90kg.
 Con ruedas dobles R47:180kg.
 Con ruedas dobles reforzadas R52:320kg.

VENTANA DE REBATIR



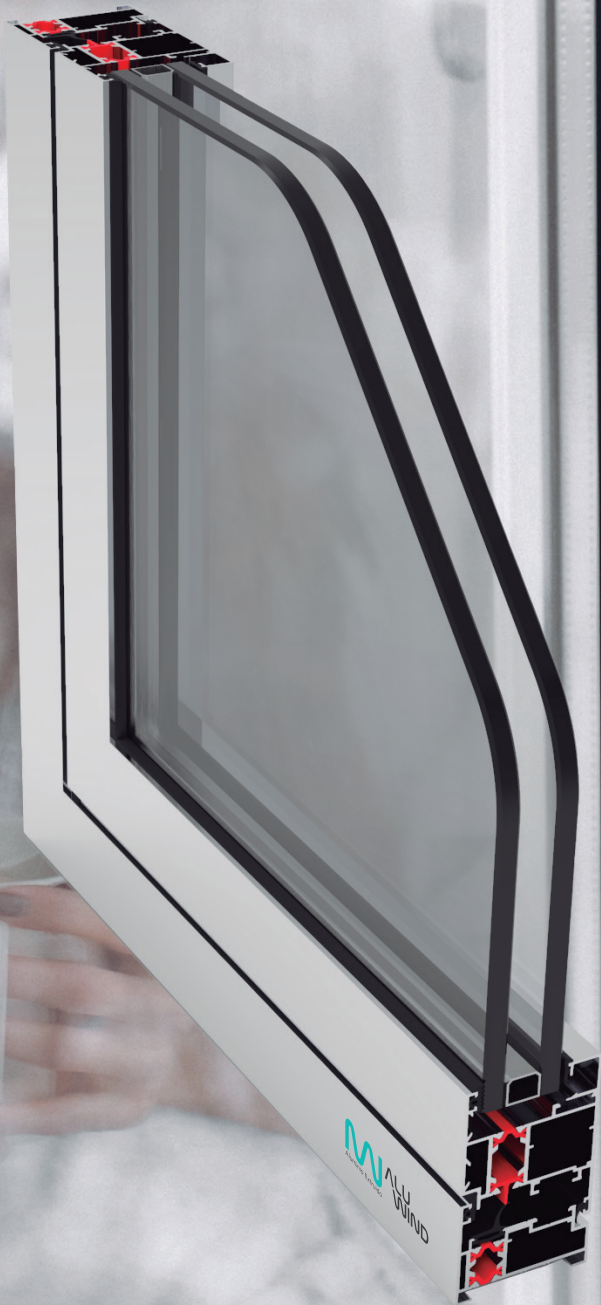







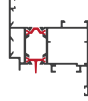

MALU
WIND
Aluminio Extruido



- Ventana de Rebatir
- Oscilobatiente
- Banderola



IMPERIA
RPT+

CÓDIGO	DESCRIPCIÓN	PESO Kg/m	FORMA	L. Std.
C 3021 i	Hoja ventana proyectante, de rebatir	1,504		6,20
C 3018 i	Marco ventana de rebatir escalonada	1,296		6,20
C 3024 i	Marco ventana de rebatir lisa	1,265		6,20
C 3046 i	Acople puerta y ventana de rebatir de 2 hojas	1,241		6,20
C 3049 i	Acople reforzado	1,007		6,20
AW 513	Tapa junta curvo	0,24		6,20
AW 514	Tapa junta recto	0,28		6,20
AW 544	Contravidrio recto a 45° de 22mm	0,192		6,20
AW 552	Contravidrio recto a 45° de 15 mm	0,170		6,20
AW 553	Contravidrio recto a 45° de 4 mm	0,141		6,20
AW 6111	Mosquitero fijo	0,121		6,20
AW 515	Premarco 50 mm	0,52		6,20



IMPERIA
RPT+

Perfiles Escala 1:1

M ALU
WIND
Aluminio Extruido



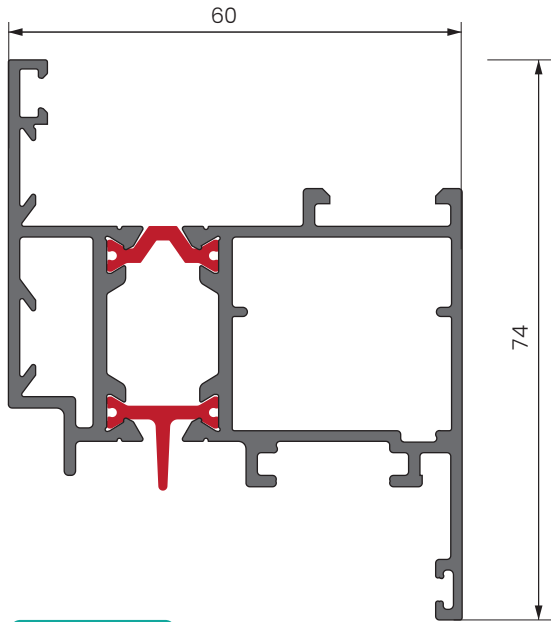

C 3021 i

Hoja de ventana de rebatir
1,504 kg/m

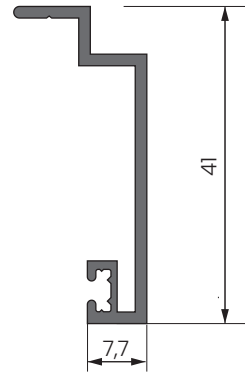

AW 514

Tapajuntas recto
0,280 Kg/m

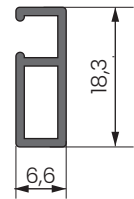

AW 611

Mosquitero fijo
0,135 Kg/m

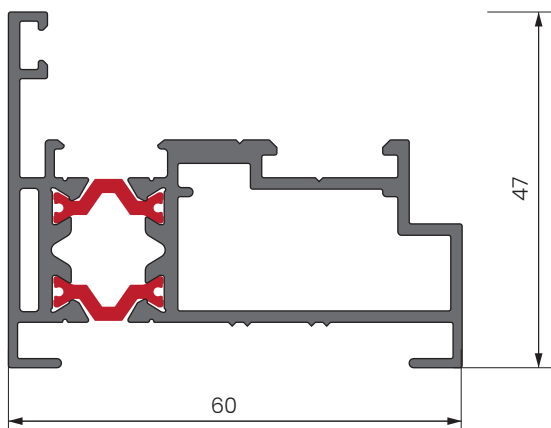

C 3024 i

Marco de ventana de rebatir liso
1,265 kg/m

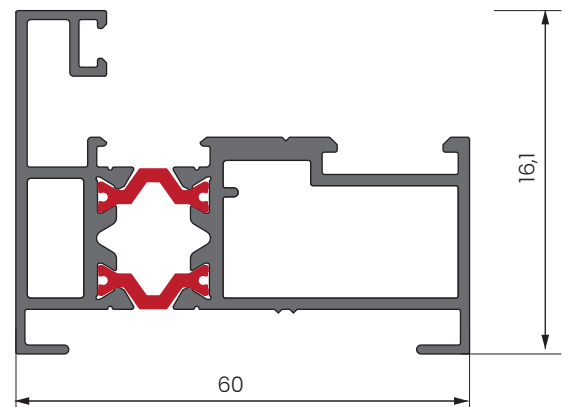

C 3018 i

Marco de ventana de rebatir escalonado
1,296 kg/m

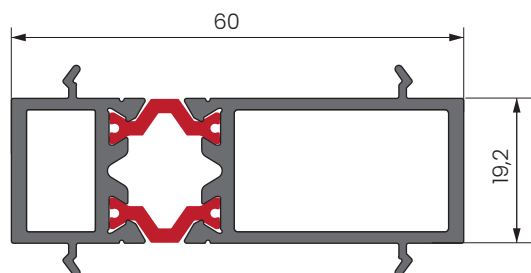

C 3049 i

Acople reforzado
1,007 kg/m

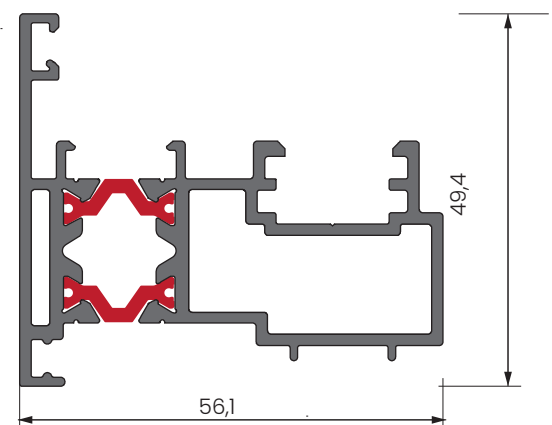

AW C3046i

Inversor de ventana de abrir de 2 hojas
1,241 kg/m

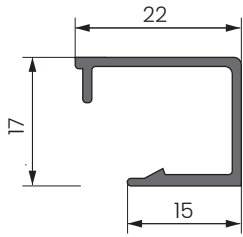

AW 544

Contravidrio de 22mm
0,192 Kg/m

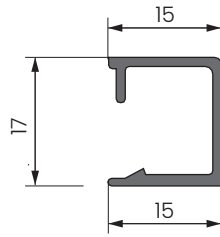

AW 552

Contravidrio de 15mm
0,170 Kg/m

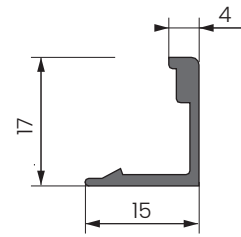

AW 553

Contravidrio de 4mm
0,141 Kg/m

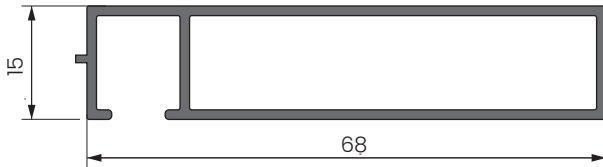

AW 564

Premarco 68mm
0,564 Kg/m

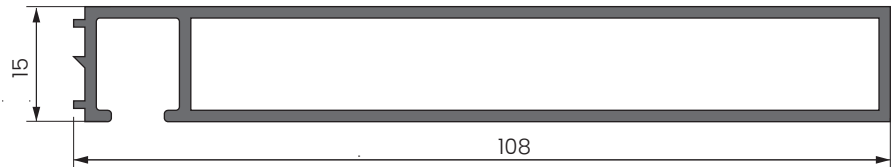

AW 596

Premarco 108mm, corrediza 3 guias
0,993 Kg/m

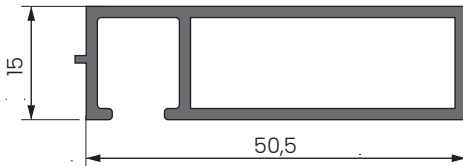

AW 515

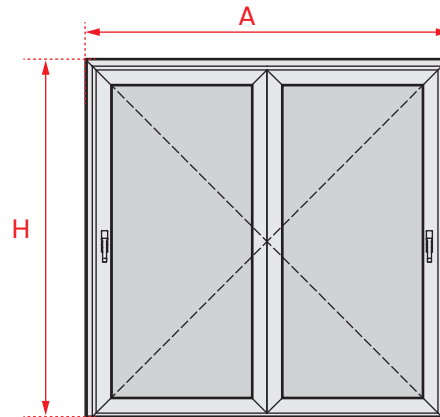

Premarco 50mm
0,523 Kg/m





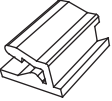

DESCUENTOS

Descuentos en perfiles



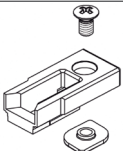

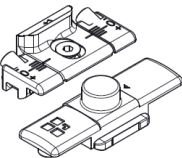

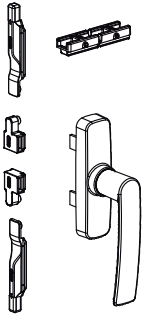
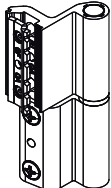

CANT.	PERFIL	MEDIDA	DESCRIPCIÓN	CORTE
2	AW-515	A +36	Premarco dintel y zocalo	45° - 45°
2	AW-515	H +33	Premarco jambas	45° - 45°
2	AW-514	A+70	Dintel y zocalo tapajuntas recto	45° - 45°
2	AW-514	H+70	Jambas tapajuntas recto	45° - 45°
4	C 3024 i	A y H	Dintel y zocalo marco liso	45° - 45°
4	C 3018 i	A y H	Dintel y zocalo marco escalonado	45° - 45°
2	C 3021 i	A -48	Dintel y zocalo hojas	45° - 45°
2	C 3021 i	H -48	Jambas hojas	45° - 45°
2	AW-544	A -164	Dintel y zocalo contravidrio recto	45° - 45°
2	AW-544	H -164	Jambas contravidrio recto	45° - 45°
4	C 3021 i	(A/2) -25	Dintel y zocalo ventana de 2 hojas	45° - 45°
1	C 3046 i	H - 104	Perfil inversor	90° - 90°
4	AW-544	(A/2) -140	Dintel y zocalo contravidrio recto. Para ventana 2 hojas	45° - 45°
2	AW 6111	A - 56	Dintel y zócalo mosquitero fijo	45° - 45°
2	AW-6111	H - 56	Jambas mosquitero fijo	45° - 45°



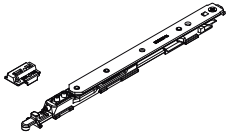
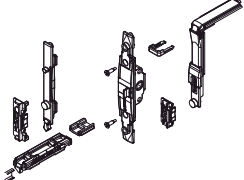

Descuentos en vidrios

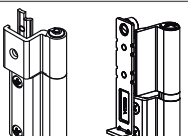
CANT.	TIPO	ANCHO	ALTO	DESCRIPCIÓN	HOJA
1	DVH	A-180	H-180	VIDRIO DOBLE VIDRIADO HERMÉTICO	C 3021 i
2	DVH	(A/2)-152	H-180	VIDRIO DOBLE VIDRIADO HERMÉTICO	C 3021 i (2 hojas)

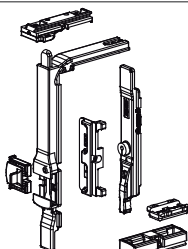
DESCRIPCIÓN	IMAGEN	CODIGO	CANT. POR ABERTURA	MARCA
BURLETE JUNTA ABIERTA		i-53	-	ALUWIND PEDIDOS WEB!
TAPA DE INVERSOR DE HOJAS		TP INRPT	1 par	ALUWIND PEDIDOS WEB!
ESCUADRA DE PREMARCOS		E78	4	MONPAT
ESCUADRA DE ALINRACION DE TAPAJUNTAS		AA-107	4	MONPAT
ESCUADRA DE ALINRACION DE HOJAS		E-66	4	TANIT
ESCUADRA DE HOJAS		E-101	4 x HOJA 4 x MARCO	TANIT
TACO REGULADOR		T-88	-	FRIUL TRADE
CLIP PARA CONTAVIDRIO		T-96	5 x M DE HOJA	GIESSE
BURLETE MARCO BURLETE INTERIOR DOBLE CONTACTO		B52	-	MONPAT
BURLETE CUÑA		B29 / B30 / B31	-	LIGOM
BURLETE EXTERIOR PARA VIDRIO		B68	-	MONPAT
BURLETE HERMETICIDAD DOBLE CONTACTO		B67	-	MONPAT
CLAPETA BOTA AGUA		T-69	2 por metro	TANIT

DESCRIPCIÓN	IMAGEN	CODIGO	CANT. POR ABERTURA	MARCA
BISAGRA FLASH		00120 ACOPLANAR 00121 COPLANAR	2	GIESSE para ABRIR
MOVIMENTADOR DE MARTELINA		01020	1	
MARTELINA KORA		0997	1	
TERMINAL, PIEZA DE MARCO DE ABRIR		01322	1	
TERMINAL FLECHA ARRIBA Y ABAJO		02114	2	
CIERRE FUTURA		04777K		
BRAZO LIMITADOR FRIZ		02030K		
TERMINAL, PIEZA DE MARCO DE ABRIR		0540B (cremona) 1946A (tapones de conexión)	1	FAPIM para ABRIR
TERMINAL, PIEZA DE MARCO DE ABRIR		9801A	2	

DESCRIPCIÓN	IMAGEN	CODIGO	CANT. POR ABERTURA	MARCA
BISAGRA INVISIBLE PARA ESCALONADO		04711	2	GIESSE para OSCILOBATIENTE
BISAGRA 2 CUERPOS, FUTURA 3D HASTA 80 KG COPLANAR (MARCO C3024i)		04718	2	
		H-61		
BISAGRA 2 CUERPOS, FUTURA 3D HASTA 130 KG ACOPLANAR (MARCO C3018i)		04711	2	
COMPAS CON MICRO-VENTILACION PARA OSCILOBATIENTE		04284 (120MM)	1	
		04285 (180MM)		
MECANISMO BASE OSCILOBATIENTE		04705	2	
MARTELINA KORA		0997	1	
MARTELINA ASIA		02415	1	
MARTELINA GALICUBE		0530Bi	1	
BISAGRA GALICUBE		1401C	1	
COMPAS GALICUBE		1448	1	
		1448Ai		
		1448Bi		
		1448C		
MECANIMO OSCILOBATIENTE GALICUBE		1461i	1	

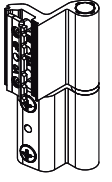
DESCRIPCIÓN	IMAGEN	CODIGO	CANT. POR ABERTURA	MARCA
CIERRE DE GOLPETE TWIN		01704	1	GIESSE para BANDEROLA
COMPAS RALLENTY		02040K compas 250mm	1 par	
		02041K compas 150mm		
BISAGRA FLASH BASE		00120 ACOPLANAR	2	
		00121 COPLANAR		
GOLPETE SUPERCLACK		3217R	1	FAPIM para BANDEROLA
COMPAS ALT TRE de engache rápido		3224B compas 220mm	2	
		3223B compas 150mm		
Bisagra GRIP		9801A	2	

DETALLE CONTRAVIDRIOS

CONTRAVIDRIOS CORTE A 45°

CONTRAVIDRIOS CORTE A 90°

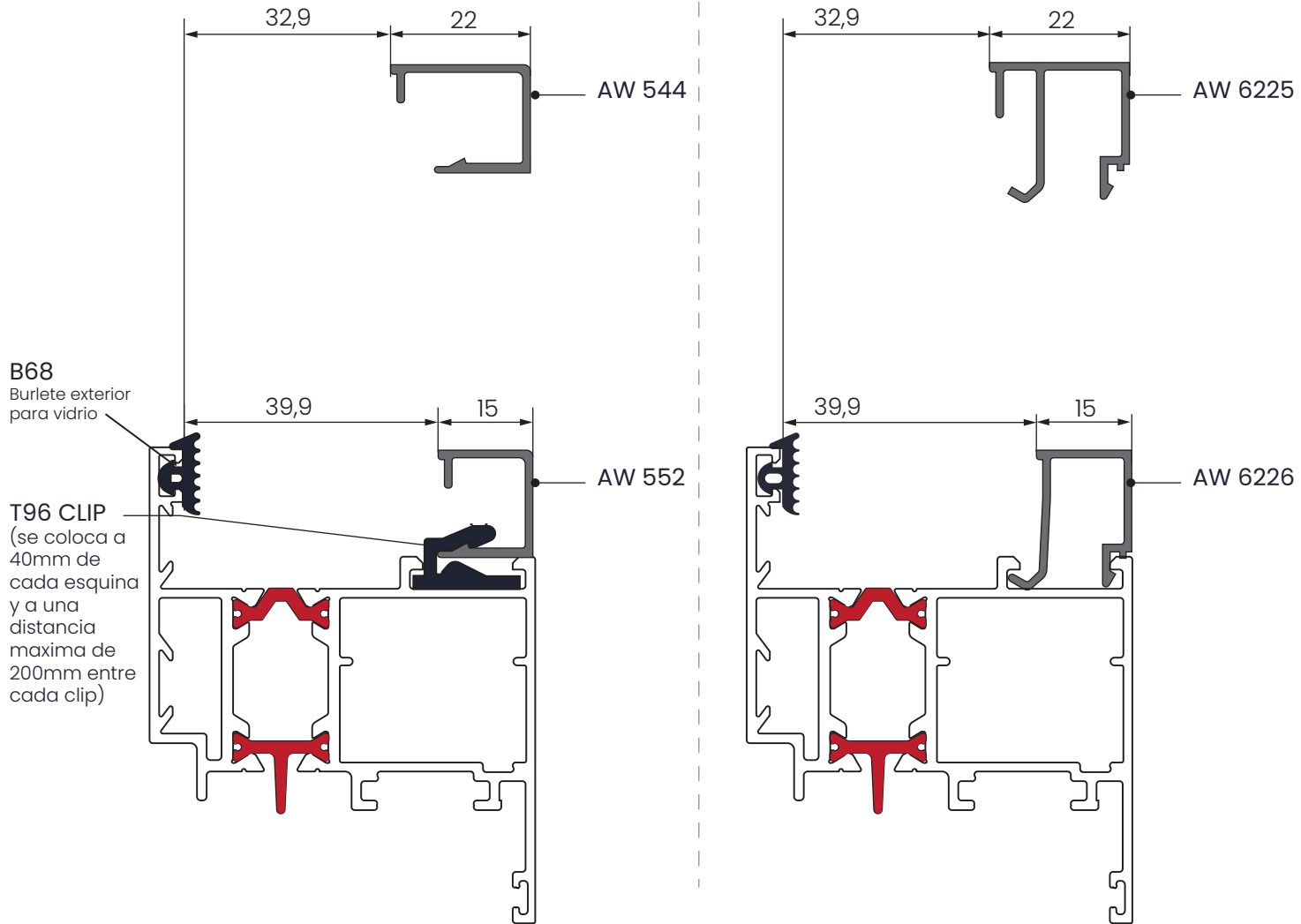

VENTANA DESPLAZABLE

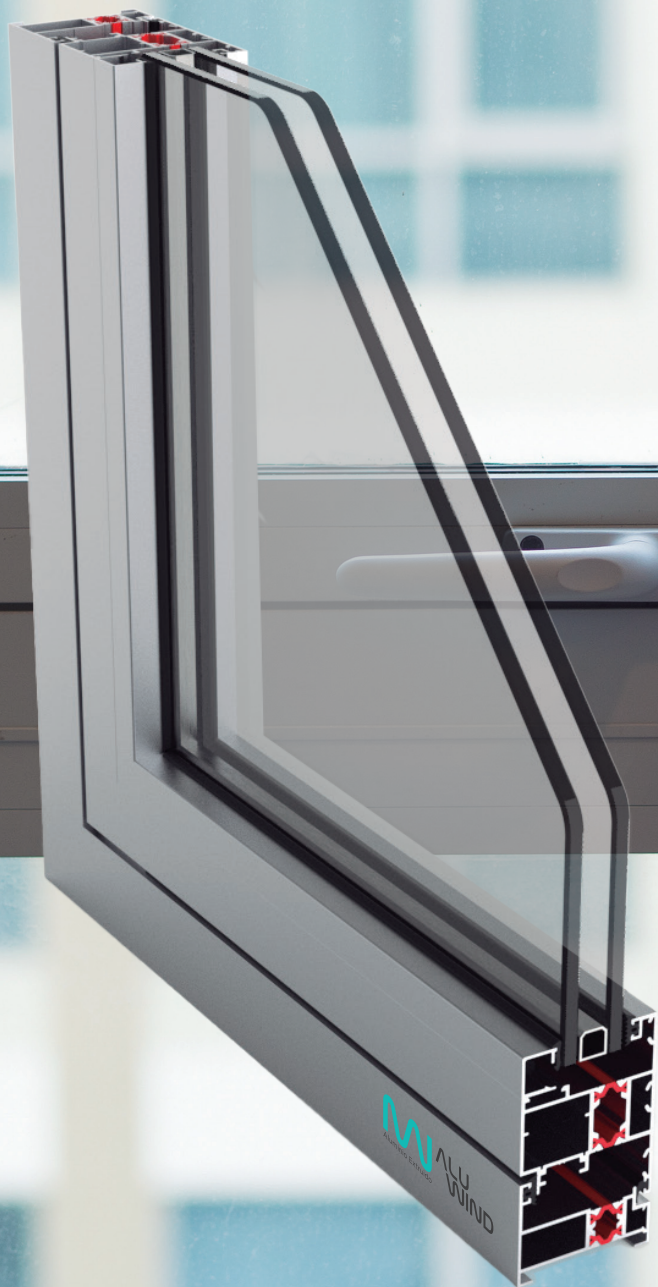





M ALU
WIND
Aluminio Extruido

 **IMPERIA**
RPT+

  AluwindSA

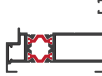
 Av. Japón 550 - Córdoba, Argentina

 aluwind.com.ar

CÓDIGO	DESCRIPCIÓN	PESO Kg/m	FORMA	L. Std.
C 3031 i	Marco de ventana desplazable	1,084		6,20
C 3034 i	Hoja de ventana desplazable	1,610		6,20
C 3049 i	Acople reforzado	1,007		6,20
AW 513	Tapa junta curvo	0,24		6,20
AW 514	Tapa junta recto	0,28		6,20
AW 544	Contravidrio recto a 45° de 22mm	0,192		6,20
AW 552	Contravidrio recto a 45° de 15 mm	0,170		6,20
AW 553	Contravidrio recto a 45° de 4 mm	0,141		6,20
AW 515	Premarco 50 mm	0,52		6,20



IMPERIA
RPT+

Perfiles Escala 1:1

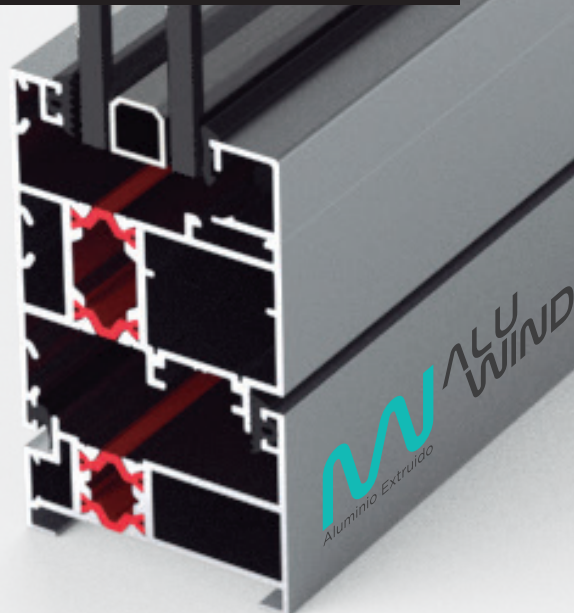

ALU WIND
Aluminio Extruido

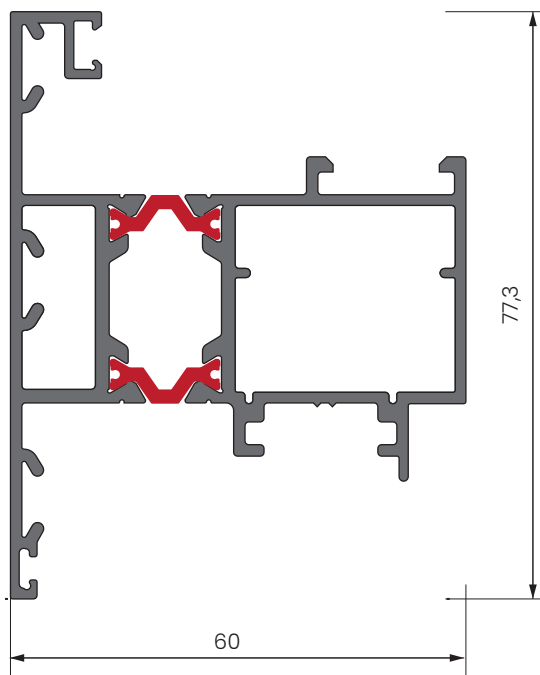

C 3034 i

Hoja desplazable
1,610 kg/m

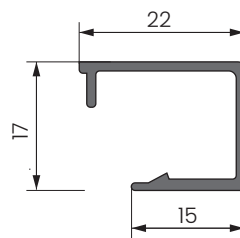

AW 544

Contravidrio de 22mm
0,192 Kg/m

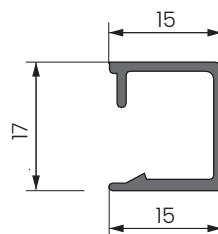

AW 552

Contravidrio de 15mm
0,170 Kg/m

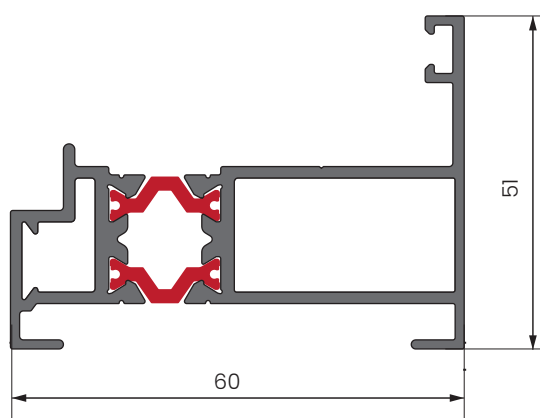

C 3031 i

Marco ventana desplazable
1,084 kg/m

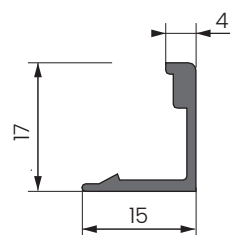

AW 553

Contravidrio de 4mm
0,141 Kg/m

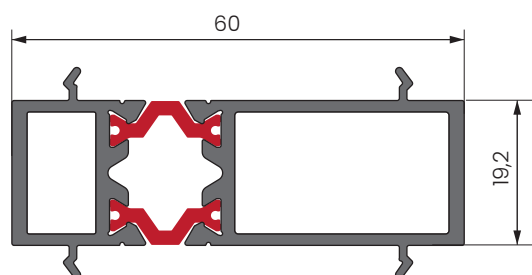

C 3049 i

Acople reforzado
1,007 kg/m

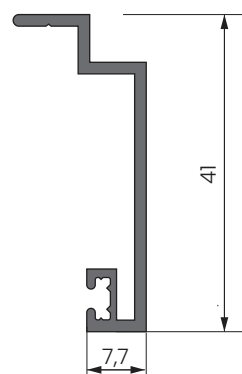

AW 514



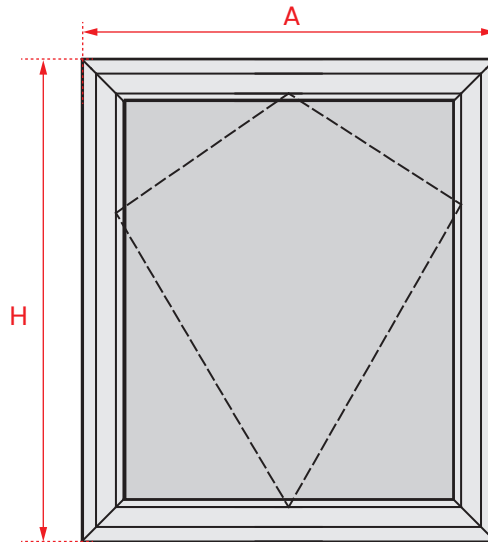



Tapajuntas recto
0,280 Kg/m

DESCUENTOS

Descuentos en perfiles

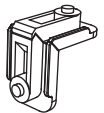
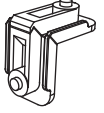
CANT.	PERFIL	MEDIDA	DESCRIPCIÓN	CORTE
2	AW-515	A +36	Premarco dintel y zocalo	45° - 45°
2	AW-515	H +33	Premarco jambas	45° - 45°
2	AW-514	A+70	Dintel y zocalo tapajuntas recto	45° - 45°
2	AW-514	H+70	Jambas tapajuntas recto	45° - 45°
4	C 3031 i	A y H	Dintel y zocalo marco	45° - 45°
2	C 3034 i	A -45	Dintel y zocalo hojas	45° - 45°
2	C 3034 i	H -30	Jambas hojas	45° - 45°
2	AW-544	A-164	Dintel y zocalo contravidrio recto	45° - 45°
2	AW-544	H -164	Jambas contravidrio recto	45° - 45°

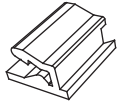
Descuentos en vidrios

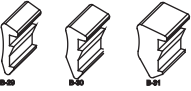
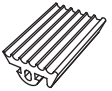
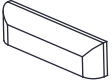
CANT.	TIPO	ANCHO	ALTO	DESCRIPCIÓN	HOJA
1	DVH	A-177	H-177	VIDRIO DOBLE VIDRIADO HERMÉTICO	C 3034 i

DESCRIPCIÓN	IMAGEN	CODIGO	CANT. POR ABERTURA	MARCA
ESCUADRA DE PREMARCOS		E78	4	MONPAT
ESCUADRA DE ALINRACION DE TAPAJUNTAS		AA-107	4	MONPAT
ESCUADRA DE MARCOS Y HOJAS		E-101	4 x HOJA 4 x MARCO	TANIT
ESCUADRA DE MARCOS		AA-003 / E-83	4	TANIT
TACO REGULADOR		T-88	-	FRIUL TRADE
CLIP PARA CONTAVIDRIO		T-96	5 x M DE HOJA	GIESSE
BURLETE HERMETICIDAD DOBLE CONTACTO		B 67	-	LIGOM
BURLETE INTERIOR DOBLE CONTACTO		B52	-	MONPAT
BURLETE CUÑA		B29 / B30 / B31	-	LIGOM
BURLETE EXTERIOR PARA VIDRIO		B68	-	MONPAT
CLAPETA BOTA AGUA		T-69	2 por metro	TANIT

DESCRIPCIÓN	IMAGEN	CODIGO	CANT. POR ABERTURA	MARCA
CIERRE A PRESION BRAVO, LINEA PRIMA SISTEMA UNIPUNTO		01642N	1	GIESSE para DESPLAZABLE
MOVIMIENTO MARTELINA PARA APERTURA EXTERNA		01026	1	
PERNO DE CONEXIÓN		02252K	1	
MANIJA ASIA		02415	1	
MANIJA PRIMA		02476	1	
MARTELINA KORA		00997	1	
PUNTO DE CIERRE FIJO		04027K	4	
ENCUENTRO REGULABLE MARCO PLANO		01269K	4	
COMPASES GS HD		16" (406MM)- PAR COD.08537N 18" (457MM)- PAR COD.08538N 20" (508MM)- PAR COD.08539N 22" (558MM)- PAR COD.08540N 24" (609MM)- PAR COD.08541N 28" (711MM)- PAR COD.08542N	1par	

DETALLE CONTRAVIDRIOS

CONTRAVIDRIOS CORTE A 45°

CONTRAVIDRIOS CORTE A 90°

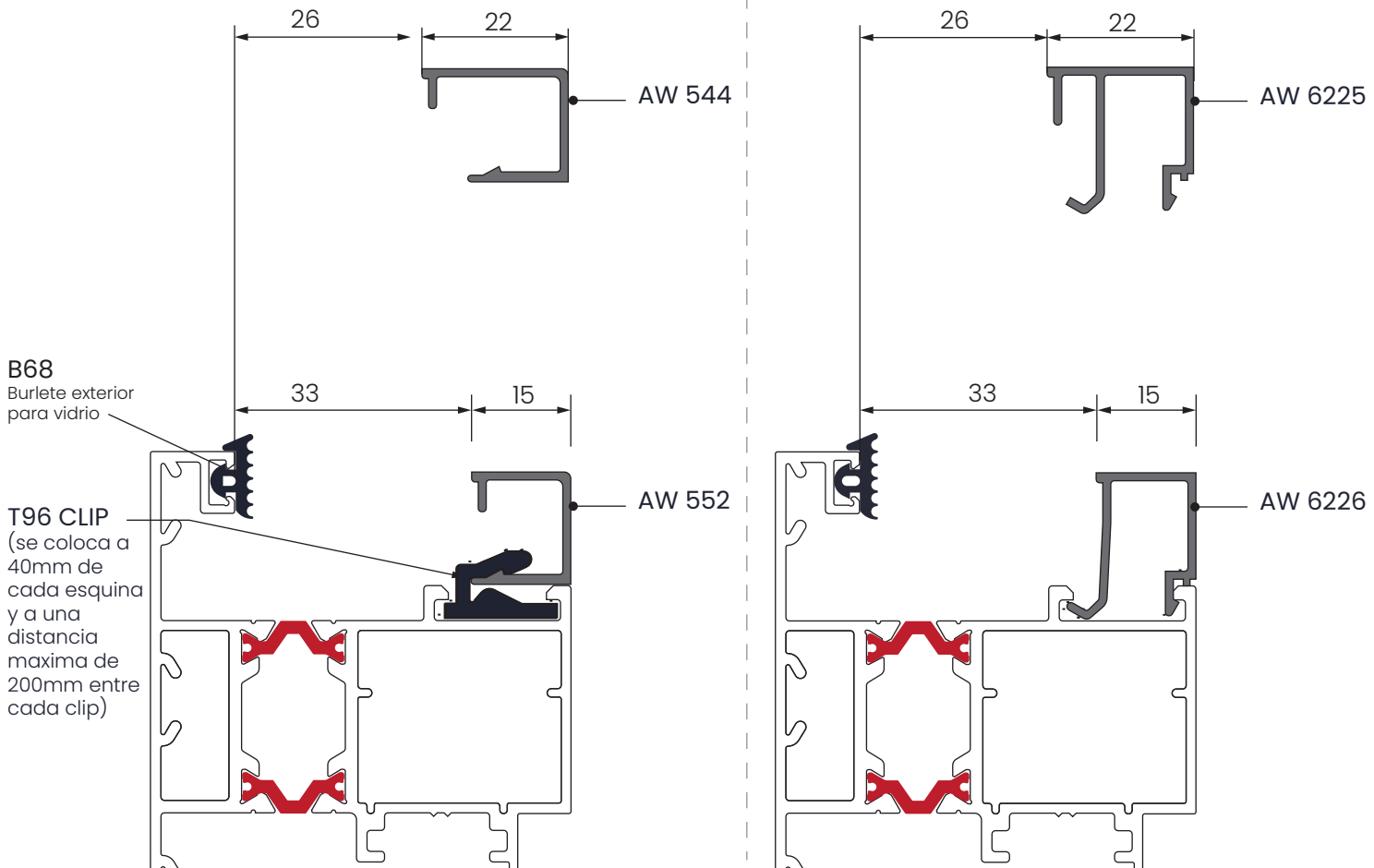









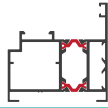
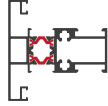
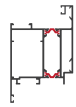

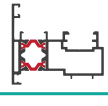

PUERTA DE REBATIR

M ALU WIND
Aluminio Extruido



 **IMPERIA**
RPT+

CÓDIGO	DESCRIPCIÓN	PESO Kg/m	FORMA	L. Std.
C 3037 i	Marco de puerta de rebatir	1,479		6,20
C 3028 i	Travesaño puerta de rebatir	1,583		6,20
C 3040 i	Hoja de puerta de rebatir	1,969		6,20
C 3043 i	Zócalo puerta de rebatir	3,258		6,20
C 3046 i	Acople puerta y ventana de rebatir de 2 hojas	1,241		6,20
C 3049 i	Acople reforzado	1,007		6,20
AW 635	Umbral transitable	0,420		6,20
AW 515	Premarco 50 mm	0,52		6,20
AW 544	Contra vidrio recto a 45° de 22mm	0,192		6,20
AW 552	Contra vidrio recto a 45° de 15 mm	0,170		6,20
AW 553	Contra vidrio recto a 45° de 4 mm	0,141		6,20
AW 6212	Contra vidrio de 36mm	0,315		6,20
AW 513	Tapa junta curvo	0,24		6,20
AW 514	Tapa junta recto	0,28		6,20



IMPERIA

RPT+

Perfiles Escala 1:1

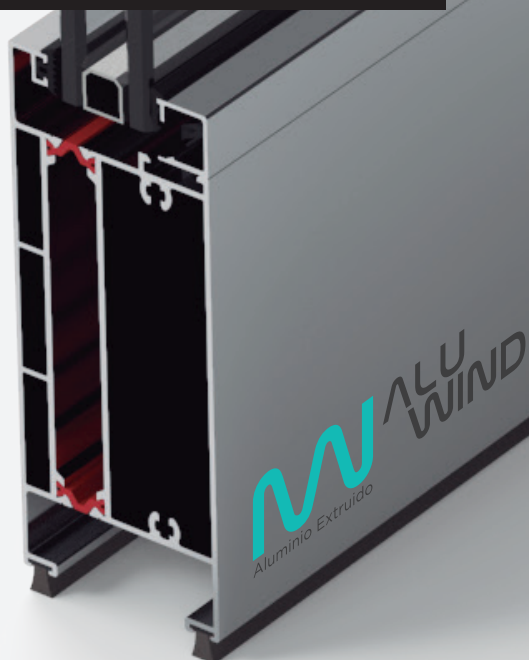

ALU WIND
Aluminio Extruido

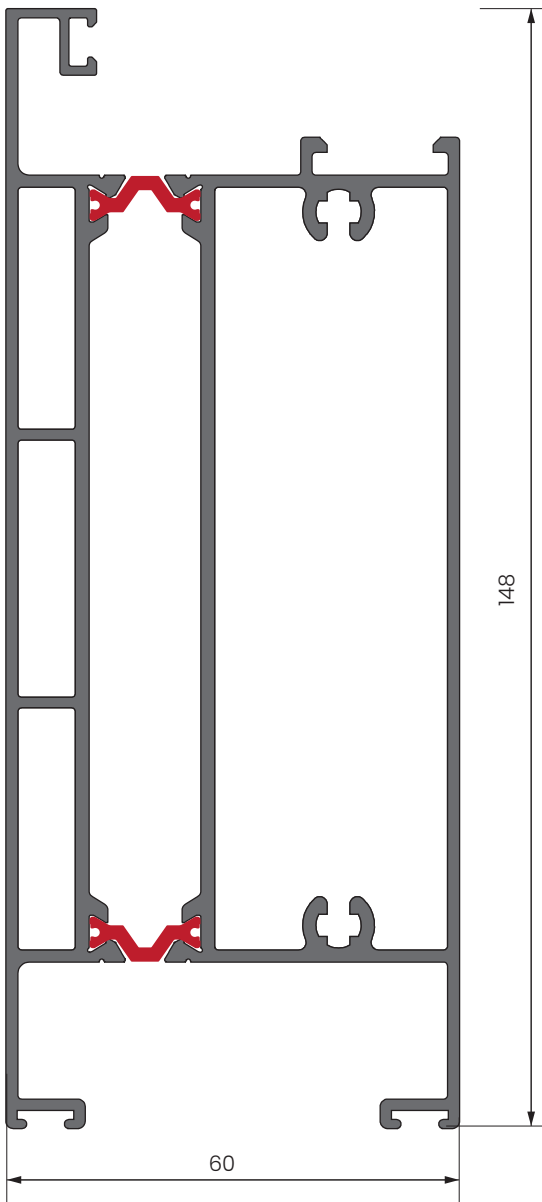

C 3043 i

Zocalo de puerta de rebatir
3,258 kg/m

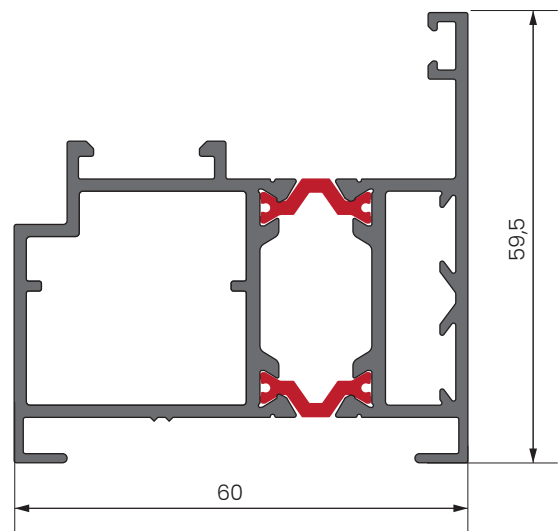

C 3037 i

Marco de puerta de rebatir
1,479 kg/m

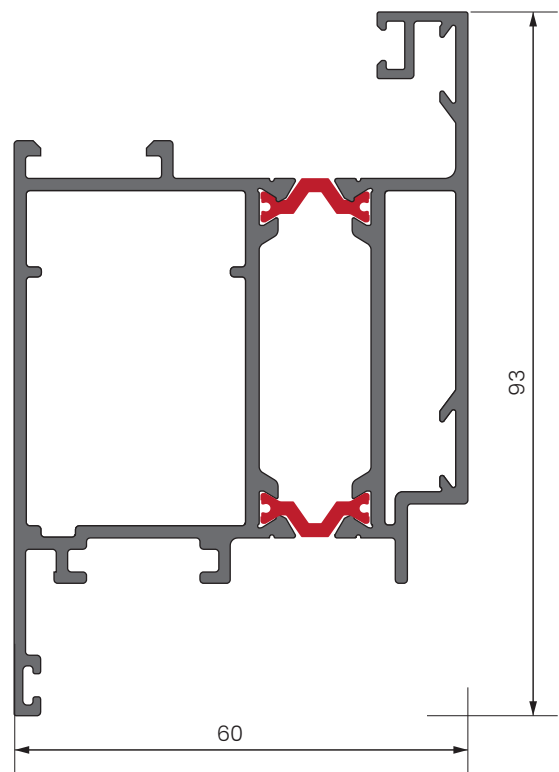

C 3040 i

Hoja de puerta de rebatir
1,969 kg/m

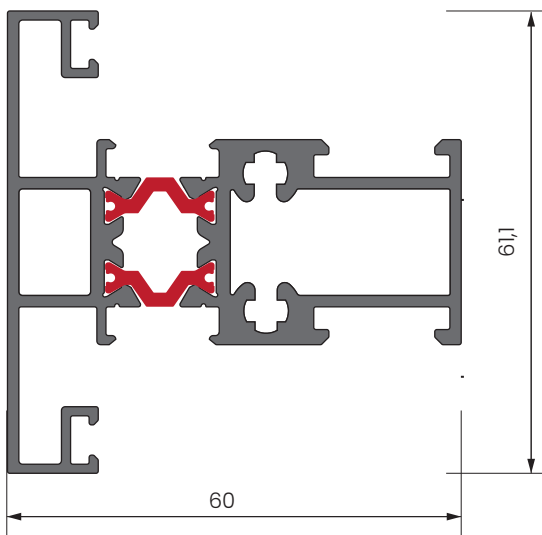

C 3028 i

Travesaño de puerta de rebatir
1,583 kg/m

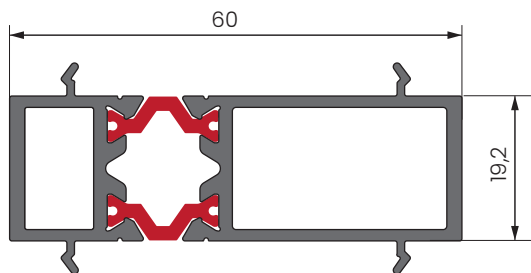

C 3049 i

Acople reforzado
1,007 kg/m

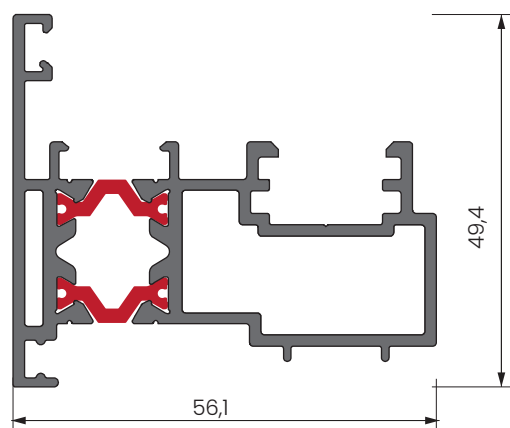

AW C3046i

Inversor de ventana de abrir de 2 hojas
1,241 kg/m

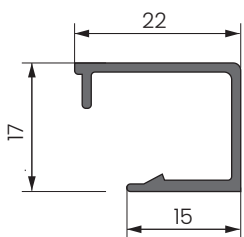

AW 544

Contravidrio de 22mm
0,192 Kg/m

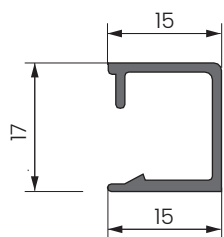

AW 552

Contravidrio de 15mm
0,170 Kg/m

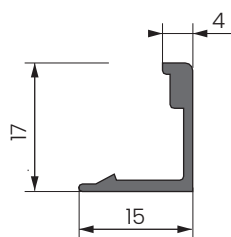

AW 553

Contravidrio de 4mm
0,141 Kg/m

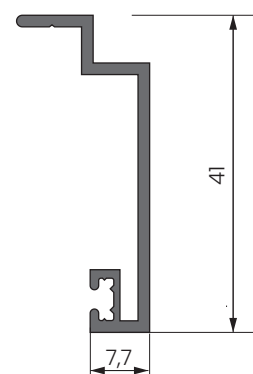

AW 514

Tapajuntas recto
0,280 Kg/m

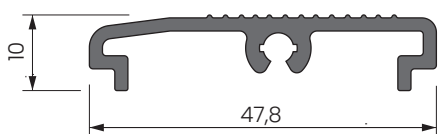

AW 635

Umbral transitable
0,420 Kg/m

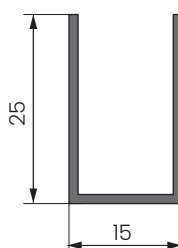

AW U15X25

Perfil U15x25
0,202 Kg/m

Descuentos puerta de rebatir SIN UMBRAL

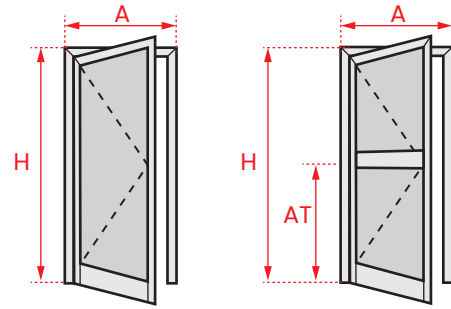

*AT = altura Al eje del travesaño

DESCUENTOS EN PERFILES

DESCUENTOS EN PERFILES

CANT.	PERFIL	MEDIDA	DESCRIPCIÓN	CORTE
1	AW-515	A +36	Premarco dintel	45° - 45°
2	AW-515	H +18	Premarco jambas	45° - 45°
1	AW-514	A+70	Dintel tapajuntas recto	45° - 45°
2	AW-514	H+34	Jambas tapajuntas recto	45° - 45°
1	C 3037 i	A	Dintel marco	45° - 45°
2	C 3037 i	H	Jambas marco	45° - 45°
1	C 3040 i	A-74	Cabezal de hojas	45° - 45°
2	C 3040 i	H-74	Jambas de hojas (con umbral)	45° - 45°
2	C 3040 l	H-42	Jambas de hojas (sin umbral)	45° - 90°
1	C 3043 i	A-216	Zocalo	90° - 90°
1	C 3028 i	A-226	Travesaño (opcional)	90° - 90°
2	AW-6212/ AW-6226/AW-6220	A-226	Dintel y zocalo contravidrio recto	90° - 90°
2	AW-6212/ AW-6226/AW-6220	H -282	Jambas contravidrio recto Sin travesaño	90° - 90°
2	AW-544	A-226	Dintel y zocalo contravidrio recto Sin travesaño	45° - 45°
2	AW-544	H -248	Jambas contravidrio recto Sin travesaño	45° - 45°
2	AW-544	A -226	Dintel y zocalo contravidrio recto Con travesaño	45° - 45°
2	AW-544	H/2 -138	Jambas contravidrio recto Con travesaño	45° - 45°

DESCUENTOS EN VIDRIOS

CANT.	TIPO	ANCHO	ALTO	DESCRIPCIÓN	HOJA
1	DVH	A-237	H-237	VIDRIO DOBLE VIDRIADO HERMÉTICO CON UMBRAL	C 3040 i
2	DVH	A-237	H-260	VIDRIO DOBLE VIDRIADO HERMÉTICO SIN UMBRAL	C 3040 i

REPLANTEAR DESCUENTOS DE CONTRAVIDRIOS SEGUN CANTIDAD Y DISPOSICION DE TRAVESAÑOS

Descuentos puerta de rebatir **CON UMBRAL**

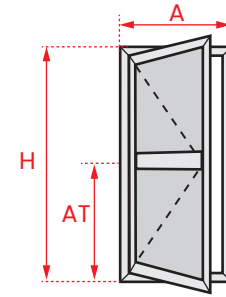
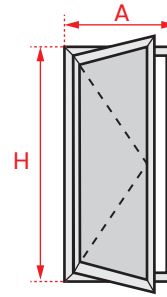

*AT = altura Al eje del travesaño

DESCUENTOS EN PERFILES







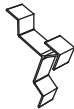

CANT.	PERFIL	PESO GR/M	MEDIDA	DESCRIPCIÓN	CORTE
1	AW-515	526	A +36	PREMARCO DINTEL	45° - 45°
2	AW-515	526	H +18	PREMARCO JAMBAS	45° - 45°
1	AW-514	286	A+70	DINTEL TAPAJUNTAS RECTO	45° - 45°
2	AW-514	286	H+34	JAMBAS TAPAJUNTAS RECTO	45° - 45°
1	C 3037 i	1479	A	DINTEL MARCO	45° - 45°
2	C 3037 i	1479	H	JAMBAS MARCO	45° - 45°
1	C 3040 i	1969	A-74	CABEZAL DE HOJAS	45° - 45°
2	C 3040 i	1969	H-74	JAMBAS DE HOJAS (con umbral)	45° - 45°
2	C 3040 i	1969	H-42	JAMBAS DE HOJAS (sin umbral)	45° - 90°
1	C 3043 i	3258	A-216	ZOCALO	90° - 90°
1	C 3028 i	1583	A-226	TRAVESAÑO (OPCIONAL)	90° - 90°
2	AW-6212/ AW-6226/AW-6220	-	A-226	DINTEL Y ZOCALO CONTRAVIDRIO RECTO	90° - 90°
2	AW-6212/ AW-6226/AW-6220	-	H -282	JAMBAS CONTRAVIDRIO RECTO SIN TRAVESAÑO	90° - 90°
2	AW-544	192	A-226	DINTEL Y ZOCALO CONTRAVIDRIO RECTO SIN TRAVESAÑO	45° - 45°
2	AW-544	192	H -248	JAMBAS CONTRAVIDRIO RECTO SIN TRAVESAÑO	45° - 45°
2	AW-544	192	A -226	DINTEL Y ZOCALO CONTRAVIDRIO RECTO CON TRAVESAÑO	45° - 45°
2	AW-544	192	H/2 -138	JAMBAS CONTRAVIDRIO RECTO CON TRAVESAÑO	45° - 45°

EN REVISIÓN

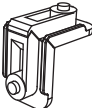
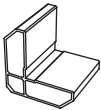
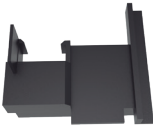
DESCUENTOS EN VIDRIOS

CANT.	TIPO	ANCHO	ALTO	DESCRIPCIÓN	HOJA
REPLANTEAR DESCUENTOS DE CONTRAVIDRIOS SEGUN CANTIDAD Y DISPOSICION DE TRAVESAÑOS					
1	DVH	A-237	H-237	VIDRIO DOBLE VIDRIADO HERMÉTICO CON UMBRAL	C 3040 i
2	DVH	A-237	H-260	VIDRIO DOBLE VIDRIADO HERMÉTICO SIN UMBRAL	C 3040 i

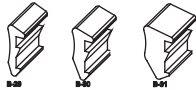
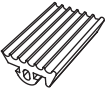





DESCRIPCIÓN	IMAGEN	CODIGO	CANT. POR ABERTURA	MARCA
ESCUADRA DE PREMARCOS		E78	2	MONPAT
ESCUADRA DE ALINRACION DE TAPAJUNTAS		AA-107	2	MONPAT
ESCUADRA DE ARMADO DE HOJA Y MARCO		E-101	4 x HOJA 4 x MARCO	TANIT
ESCUADRA SUPLEMENTARIA HOJA PUERTA DE REBATIR		E-80	2 x HOJA	TANIT MONPAT
TAPA DE INVERSOR DE HOJAS		TP INRPT	1 par	ALUWIND PEDIDOS WEB!
ESCUADRA DE TRAVESAÑO		E71	2x TRAVESAÑO	TANIT MONPAT
TACO REGULADOR		T-88	-	FRIUL TRADE
CLIP PARA CONTAVIDRIO		T-96	5 x M DE HOJA	GIESSE
BURLETE MARCO				
BURLETE INTERIOR DOBLE CONTACTO		B52	-	MONPAT
BURLETE CUÑA		B29 / B30 / B31	-	LIGOM
BURLETE EXTERIOR PARA VIDRIO		B68	-	MONPAT
BURLETE HERMETICIDAD DOBLE CONTACTO		B67	-	MONPAT
TAPA TORNILLOS REBATIR		T-100	-	TANIT

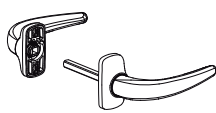
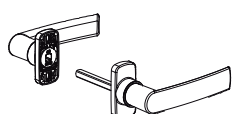

DESCRIPCIÓN	IMAGEN	CODIGO	CANT. POR ABERTURA	MARCA
MANIJA ASIA		02415	1 par	GIESSE para PUERTA DE REBATIR
MANIJA PRIMA		02792	1 par	
BISAGRA FULCRA		00702	3	
BISAGRA DOMINA HP 2 ALAS 62,5MM		05160V	2	
TORNILLO L 65mm		05230	2	
CERRADURA PARA CIERRE PERIMETRAL E=35 MM CON CONEX.		04646	1	
CONTRAFRENTE REGULABLE, CERRADERO		04655	1	
PASADOR		02188K	1	
CILINDRO DOBLE 30/55		04652N	1	
RECIBIDOR DE PISO		02183	1	
ENCUENTRO PLET.3º.P. CIERRE		01322	1	
ANGULO DE REENVIO GAGS.		04019K	1	
CIERRE ANTIEFRACCION		04031K	1	

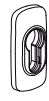
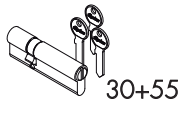
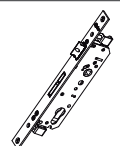
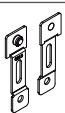
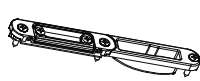
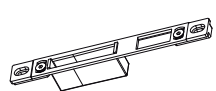
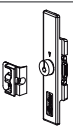
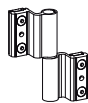

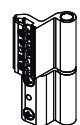
DESCRIPCIÓN	IMAGEN	CODIGO	CANT. POR ABERTURA	MARCA
MANIJA HORUS MIDI DOBLE BALANCIN		2053iA	1	FAPIM para PUERTA DE REBATIR
MANIJA HERA DOBLE BALANCIN		2041	1	
PLACA CUBRECILINDRO		2100B	2	
PLACA CUBRECILINDRO HORUS MIDI		2100C	2	
CILINDRO CERRADURA EGO 85 MM (30+55)		2755BG	1	
CERRADURA EGO UN PUNTO DE CIERRE		2501C 2503C 2523C	1	
CONEXIONES PARA VARILLAS		2628	1	
ENCUENTRO REGULABLE PARA CÁMARA EUROPEA		2620	1	
ENCUENTRO REGULABLE PARA PERFILES SIN CANAL O CÁMARA EUROPEA		2618	1	
PUNTO DE CIERRE SUPLEMENTARIO INTERMEDIO REGULABLE		1585	2 con agulo de reenvio lleva 3	
BISAGRA VENICE BABY PARA PERFILES COPLANARES		5603T	3	
BISAGRA MONZA		5671T	3	
ANGULIO DE REENVIO		1515A	1	
TERMINAL, PIEZA DE MARCO DE ABRIR		9801A	3	

DETALLE CONTRAVIDRIOS

CONTRAVIDRIOS CORTE A 45°

CONTRAVIDRIOS CORTE A 90°

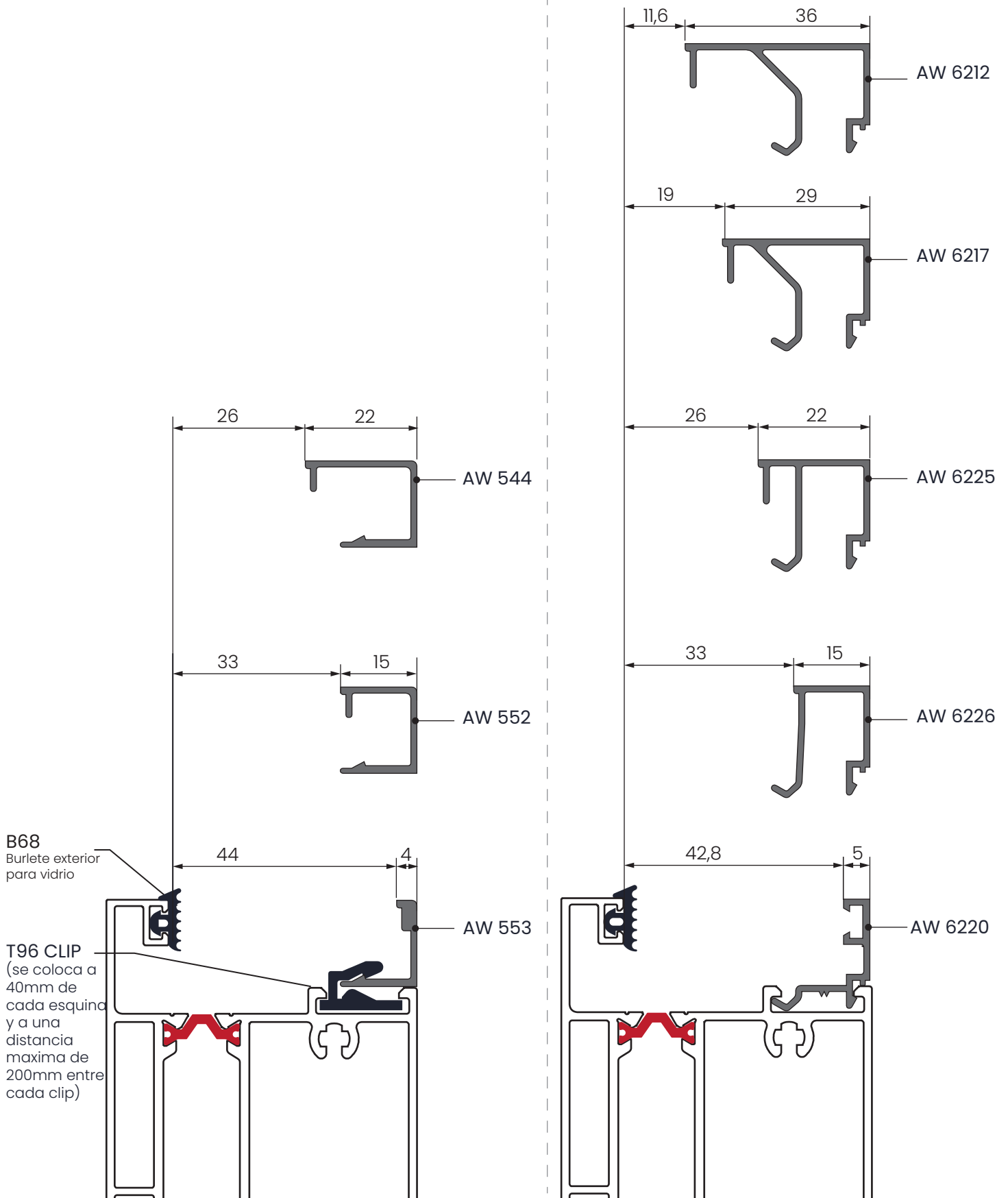

Ventana de abrir

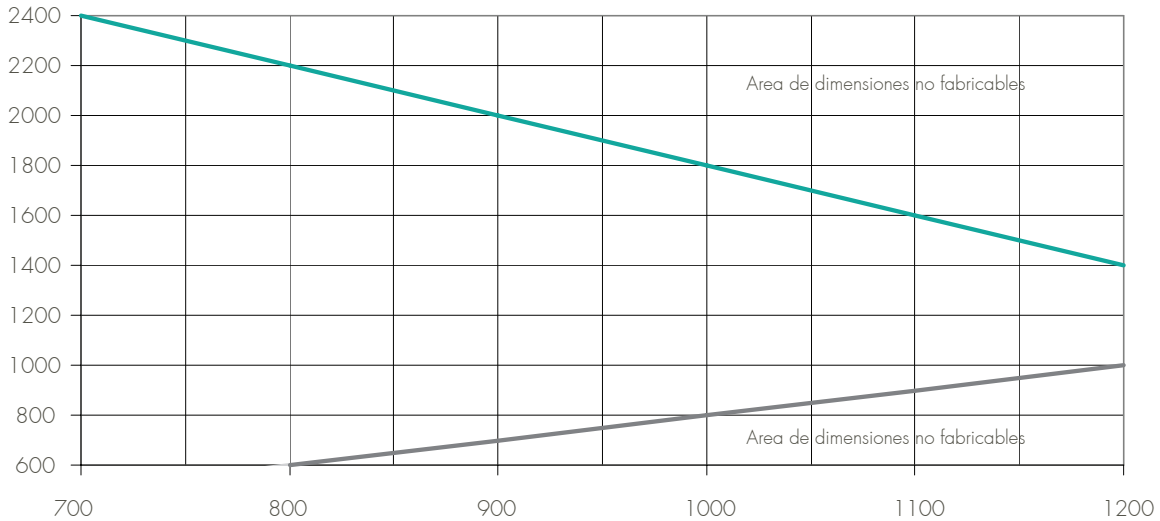

Ventana de abrir:

Para alto máx. 1600 hasta ancho 1000, utilizar 2 bisagras H61 (75 kg). Para más de 1000, utilizar 2 bisagras H62 (75 kg).
 Para alto máx. 2400 hasta ancho 1000, utilizar 3 bisagras H61 (85 kg). Para más de 1000, utilizar 3 bisagras H62 (85 kg)

Ventana oscilobatiente: peso máximo y dimensión mínima consultar con el fabricante del mecanismo.

Puerta de rebatir

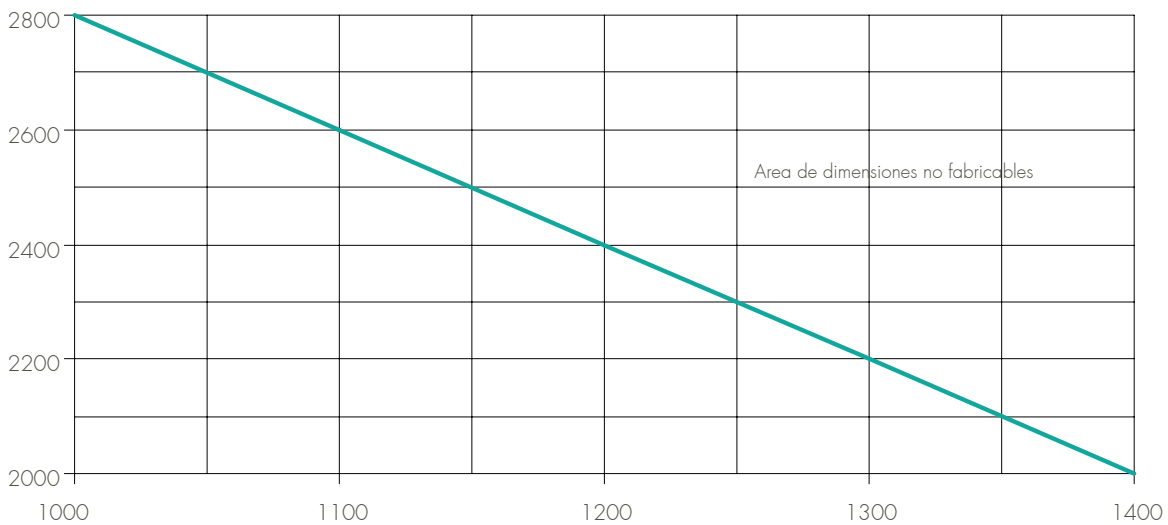

Puerta de rebatir:







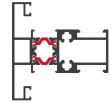

Hasta ancho 1000 utilizar 3 bisagras H61 (85 kg) ó 3 bisagras H103 (120 kg). Para más de 1000, utilizar 3 bisagras H62 (85 kg) ó 3 bisagras H104 (140 kg).

Puerta vaivén: consultar con el fabricante de caja de piso por el peso máximo admisible.

PAÑO FIJO

40

Ultimere - realización 07/11/2024

CÓDIGO	DESCRIPCIÓN	PESO Kg/m	FORMA	L. Std.
C 3018 i	Marco paño fijo	1,296		6,20
C 3028 i	Travesaño paño fijo	1,583		6,20
C 3049 i	Acople reforzado	1,007		6,20
AW 513	Tapa junta curvo	0,24		6,20
AW 514	Tapa junta recto	0,28		6,20
AW 544	Contravidrio recto a 45° de 22mm	0,192		6,20
AW 552	Contravidrio recto a 45° de 15 mm	0,170		6,20
AW 553	Contravidrio recto a 45° de 4 mm	0,141		6,20
AW 6111	Mosquitero fijo	0,121		6,20
AW 515	0,52		6,20	



IMPERIA

RPT+

Perfiles Escala 1:1



M ALU
WIND
Aluminio Extruido

M ALU
WIND
Aluminio Extruido

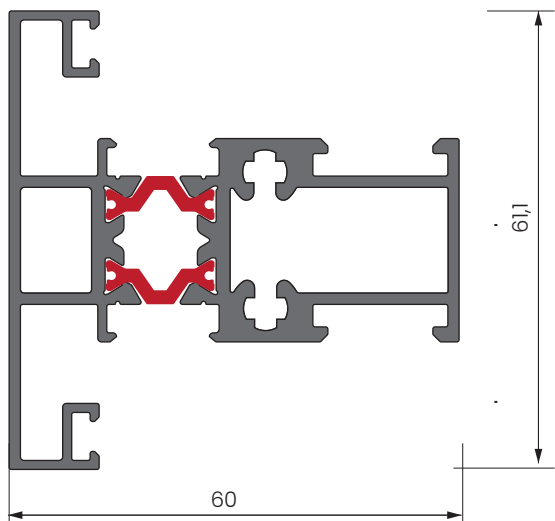

C 3028 i

Travesaño paño fijo y puerta de rebatir
1,583 kg/m

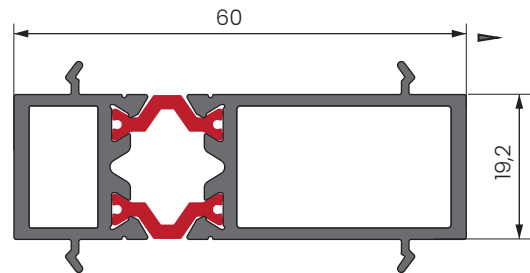

C 3049 i

Acople reforzado
1,007 kg/m

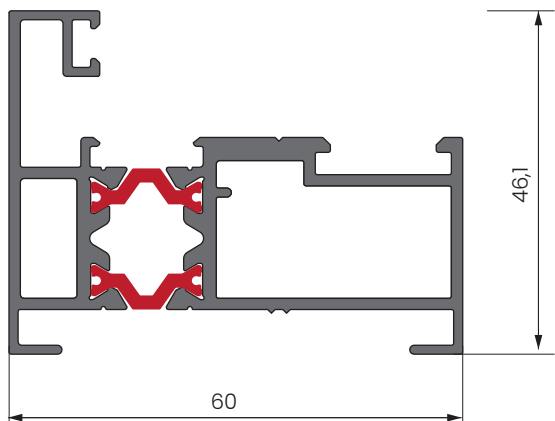

C 3018 i

Marco de ventana de rebatir escalonado
1,296 kg/m

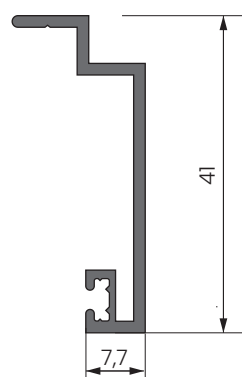

AW 514

Tapajuntas recto
0,280 Kg/m

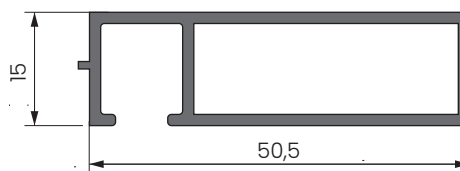

AW 515

Premarco 50mm
0,523 Kg/m

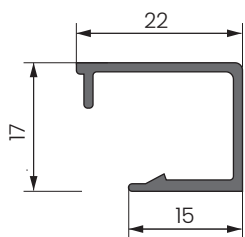

AW 544

Contravidrio de 22mm
0,192 Kg/m

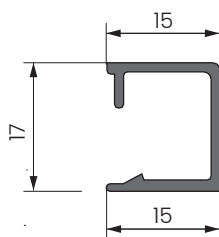

AW 552

Contravidrio de 15mm
0,170 Kg/m

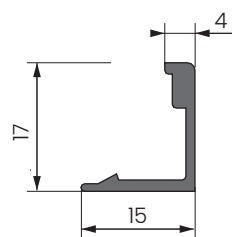





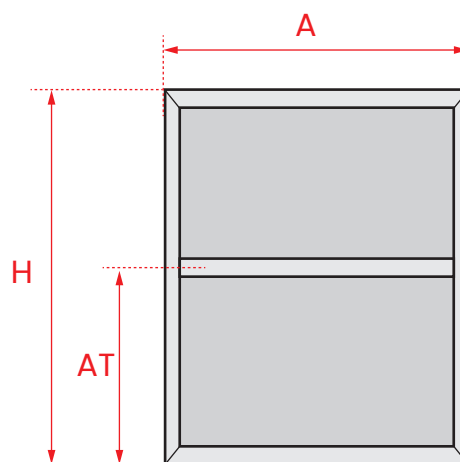
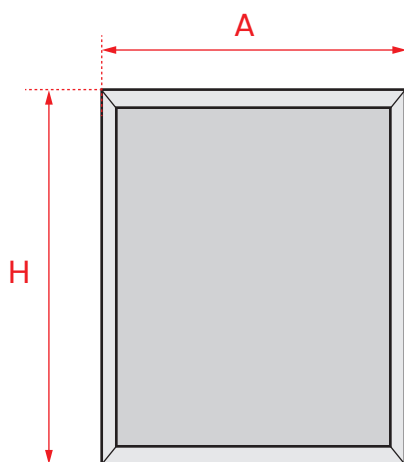

AW 553

Contravidrio de 4mm
0,141 Kg/m

DESCUENTOS

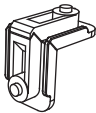
CANT.	PERFIL	MEDIDA	DESCRIPCIÓN	CORTE
2	AW-515	A +36	Premarco dintel y zocalo	45° - 45°
2	AW-515	H +33	Premarco jambas	45° - 45°
2	AW-514	A+70	Dintel y zocalo tapajuntas recto	45° - 45°
2	AW-514	H+70	Jambas tapajuntas recto	45° - 45°
4	C 3018 i	A y H	Dintel y zocalo marco	45° - 45°
2	AW-544	A -58	Dintel y zocalo contravidrio recto Sin travesaño	45° - 45°
2	AW-544	H -58	Jambas contravidrio recto Sin travesaño	45° - 45°
2	AW-544	H -58	Jambas contravidrio recto Sin travesaño	45° - 45°
2	AW-544	H -58	Jambas contravidrio recto Sin travesaño	45° - 45°
2	AW-6226	A -58	Dintel y zocalo contravidrio recto Sin travesaño	90° - 90°
2	AW-6226	H -92	Jambas contravidrio recto Sin travesaño	90° - 90°
1	C 3028 i	H -58	Travesaño vertical	90° - 90°
1	C 3028 i	A -58	Travesaño horizontal	90° - 90°

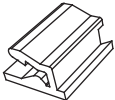
REPLANTEAR DESCUENTOS DE CONTRAVIDRIOS SEGUN CANTIDAD Y DISPOSICION DE TRAVESAÑOS

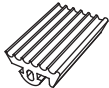
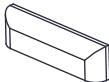
DESCRIPCIÓN	IMAGEN	CODIGO	CANT. POR ABERTURA	MARCA
ESCUADRA DE PREMARCOS		E78	4	MONPAT
ESCUADRA DE ALINRACION DE TAPAJUNTAS		AA-107	4	MONPAT
ESCUADRA DE MARCOS		E-101	4 x HOJA 4 x MARCO	TANIT
TACO REGULADOR		T-88	-	FRIUL TRADE
CLIP PARA CONTAVIDRIO		T-96	5 x M DE HOJA	GIESSE
BURLETE CUÑA		B29 / B30 / B31	-	LIGOM
BURLETE EXTERIOR PARA VIDRIO		B68	-	MONPAT
CLAPETA BOTA AGUA		T-69	2 por metro	TANIT

DETALLE CONTRAVIDRIOS

CONTRAVIDRIOS CORTE A 45°

CONTRAVIDRIOS CORTE A 90°

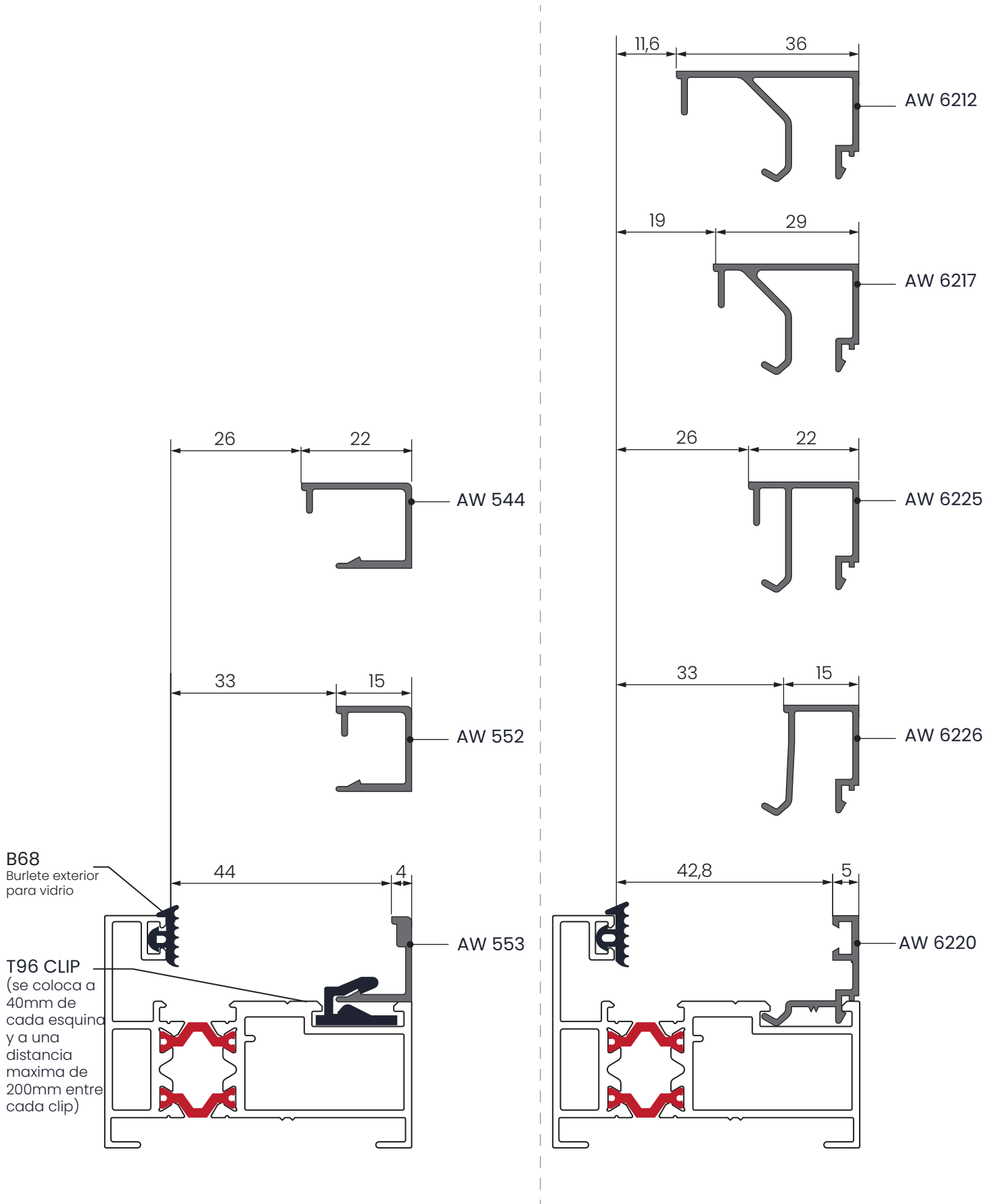



 (0351) 695 7920  aluwind.com.ar    AluwindSA

 Av. Japón 550 - Córdoba, Argentina

